

# 2013 FORMULA ONE TECHNICAL REGULATIONS

## CONTENTS SUMMARY

	<b>Pages</b>
<b>ARTICLE 1 : DEFINITIONS</b>	Pages 6-7
1.1 Formula One Car	
1.2 Automobile	
1.3 Land Vehicle	
1.4 Bodywork	
1.5 Wheel	
1.6 Complete wheel	
1.7 Automobile Make	
1.8 Event	
1.9 Weight	
1.10 Cubic capacity	
1.11 Supercharging	
1.12 Cockpit	
1.13 Sprung suspension	
1.14 Survival cell	
1.15 Camera	
1.16 Camera housing	
1.17 Cockpit padding	
1.18 Brake caliper	
1.19 Electronically controlled	
1.20 Kinetic Energy Recovery System (KERS)	
1.21 Open and closed sections	
<b>ARTICLE 2 : GENERAL PRINCIPLES</b>	Page 8
2.1 Role of the FIA	
2.2 Amendments to the regulations	
2.3 Dangerous construction	
2.4 Compliance with the regulations	
2.5 New systems or technologies	
2.6 Measurements	
2.7 Duty of competitor	
<b>ARTICLE 3 : BODYWORK AND DIMENSIONS</b>	Pages 9-19
3.1 Wheel centre line	
3.2 Height measurements	
3.3 Overall width	
3.4 Width ahead of the rear wheel centre line	
3.5 Width behind the rear wheel centre line	
3.6 Overall height	
3.7 Front bodywork	
3.8 Bodywork in front of the rear wheels	
3.9 Bodywork between the rear wheels	
3.10 Bodywork behind the rear wheel centre line	

- 3.11 Bodywork around the front wheels
- 3.12 Bodywork facing the ground
- 3.13 Skid block
- 3.14 Overhangs
- 3.15 Aerodynamic influence
- 3.16 Upper bodywork
- 3.17 Bodywork flexibility
- 3.18 Driver adjustable bodywork

**ARTICLE 4 : WEIGHT**

Page 20

- 4.1 Minimum weight
- 4.2 Weight distribution
- 4.3 Weight of tyres
- 4.4 Ballast
- 4.5 Adding during the race

**ARTICLE 5 : ENGINES AND KINETIC ENERGY RECOVERY SYSTEMS**

Pages 21-29

- 5.1 Engine specification
- 5.2 Other means of propulsion
- 5.3 Engine dimensions
- 5.4 Weight and centre of gravity
- 5.5 Engine torque demand
- 5.6 Engine control
- 5.7 Engine high rev limits
- 5.8 Exhaust systems
- 5.9 Variable geometry systems
- 5.10 Fuel systems
- 5.11 Electrical systems
- 5.12 Engine actuators
- 5.13 Engine auxiliaries
- 5.14 Engine intake air
- 5.15 Materials and construction - Definitions
- 5.16 Materials and construction – General
- 5.17 Materials and construction – Components
- 5.18 Starting the engine
- 5.19 Stall prevention systems
- 5.20 Replacing engine parts

**ARTICLE 6 : FUEL SYSTEM**

Pages 29-30

- 6.1 Fuel tanks
- 6.2 Fittings and piping
- 6.3 Crushable structure
- 6.4 Fuel tank fillers
- 6.5 Refuelling
- 6.6 Fuel draining and sampling

**ARTICLE 7 : OIL AND COOLANT SYSTEMS**

Page 31

- 7.1 Location of oil tanks
- 7.2 Longitudinal location of oil system
- 7.3 Catch tank
- 7.4 Transversal location of oil system
- 7.5 Coolant header tank
- 7.6 Cooling systems
- 7.7 Oil and coolant lines

<b>ARTICLE 8 : ELECTRICAL SYSTEMS</b>	Pages 32-35
8.1 Software and electronics inspection	
8.2 Control electronics	
8.3 Start systems	
8.4 Data acquisition	
8.5 Telemetry	
8.6 Driver controls and displays	
8.7 Driver radio	
8.8 Accident data recorders (ADR)	
8.9 Track signal information display	
8.10 Medical warning system	
8.11 Installation of electrical systems or components	
<b>ARTICLE 9 : TRANSMISSION SYSTEM</b>	Pages 36-39
9.1 Transmission types	
9.2 Clutch control	
9.3 Traction control	
9.4 Clutch disengagement	
9.5 Gearboxes	
9.6 Gear ratios	
9.7 Reverse gear	
9.8 Gear changing	
9.9 Torque transfer systems	
9.10 Kinetic Energy Recovery System	
<b>ARTICLE 10 : SUSPENSION AND STEERING SYSTEMS</b>	Pages 40-41
10.1 Sprung suspension	
10.2 Suspension geometry	
10.3 Suspension members	
10.4 Steering	
10.5 Suspension uprights	
<b>ARTICLE 11 : BRAKE SYSTEM</b>	Pages 42-43
11.1 Brake circuits and pressure distribution	
11.2 Brake calipers	
11.3 Brake discs and pads	
11.4 Air ducts	
11.5 Brake pressure modulation	
11.6 Liquid cooling	
<b>ARTICLE 12 : WHEELS AND TYRES</b>	Pages 44-46
12.1 Location	
12.2 Number of wheels	
12.3 Wheel material	
12.4 Wheel dimensions	
12.5 Supply of tyres	
12.6 Specification of tyres	
12.7 Treatment of tyres	
12.8 Wheel assembly	
<b>ARTICLE 13 : COCKPIT</b>	Pages 47-48
13.1 Cockpit opening	
13.2 Steering wheel	
13.3 Internal cross section	

13.4 Position of the driver's feet

**ARTICLE 14 : SAFETY EQUIPMENT**

Pages 49-52

14.1 Fire extinguishers

14.2 Master switch

14.3 Rear view mirrors

14.4 Safety belts

14.5 Rear light

14.6 Cockpit padding

14.7 Wheel retention

14.8 Seat fixing and removal

14.9 Head and neck supports

**ARTICLE 15 : CAR CONSTRUCTION**

Pages 53-58

15.1 Permitted materials

15.2 Roll structures

15.3 Structure behind the driver

15.4 Survival cell specifications

15.5 Survival cell safety requirements

**ARTICLE 16 : IMPACT TESTING**

Pages 59-61

16.1 Conditions applicable to all impact tests

16.2 Frontal test 1

16.3 Frontal test 2

16.4 Side test

16.5 Rear test

16.6 Steering column test

**ARTICLE 17 : ROLL STRUCTURE TESTING**

Page 63

17.1 Conditions applicable to both roll structure tests

17.2 Principal roll structure test

17.3 Second roll structure test

**ARTICLE 18 : STATIC LOAD TESTING**

Pages 64-66

18.1 Conditions applicable to all static load tests

18.2 Survival cell side tests

18.3 Fuel tank floor test

18.4 Cockpit floor test

18.5 Cockpit rim tests

18.6 Nose push off test

18.7 Side intrusion test

18.8 Rear impact structure push off test

18.9 Side impact structure push off tests

**ARTICLE 19 : FUEL**

Pages 67-69

19.1 Purpose of Article 19

19.2 Definitions

19.3 Properties

19.4 Composition of the fuel

19.5 Air

19.6 Safety

19.7 Fuel approval

19.8 Sampling and testing at an Event

**ARTICLE 20 : TELEVISION CAMERAS AND TIMING TRANSPONDERS**

Page 70

- 20.1 Presence of cameras and camera housings
- 20.2 Location of camera housings
- 20.3 Location and fitting of camera and equipment
- 20.4 Transponders
- 20.5 Installation

**ARTICLE 21 : FINAL TEXT**

Page 71

## **ARTICLE 1: DEFINITIONS**

### **1.1 Formula One Car :**

An automobile designed solely for speed races on circuits or closed courses.

### **1.2 Automobile :**

A land vehicle running on at least four non-aligned complete wheels, of which at least two are used for steering and at least two for propulsion.

### **1.3 Land vehicle :**

A locomotive device propelled by its own means, moving by constantly taking real support on the earth's surface, of which the propulsion and steering are under the control of a driver aboard the vehicle.

### **1.4 Bodywork :**

All entirely sprung parts of the car in contact with the external air stream, except cameras, camera housings and the parts definitely associated with the mechanical functioning of the engine, transmission and running gear. Airboxes, radiators and engine exhausts are considered to be part of the bodywork.

### **1.5 Wheel :**

Flange and rim.

### **1.6 Complete wheel :**

Wheel and inflated tyre. The complete wheel is considered part of the suspension system.

### **1.7 Automobile Make :**

In the case of Formula racing cars, an automobile make is a complete car. When the car manufacturer fits an engine which it does not manufacture, the car shall be considered a hybrid and the name of the engine manufacturer shall be associated with that of the car manufacturer. The name of the car manufacturer must always precede that of the engine manufacturer. Should a hybrid car win a Championship Title, Cup or Trophy, this will be awarded to the manufacturer of the car.

### **1.8 Event :**

Any event entered into the FIA F1 Championship Calendar for any year commencing at the scheduled time for scrutineering and sporting checks and including all practice and the race itself and ending at the later of the time for the lodging of a protest under the terms of the Sporting Code and the time when a technical or sporting verification has been carried out under the terms of that Code.

### **1.9 Weight :**

Is the weight of the car with the driver, wearing his complete racing apparel, at all times during the Event.

### **1.10 Cubic capacity :**

The volume swept in the cylinders of the engine by the movement of the pistons. This volume shall be expressed in cubic centimetres. In calculating engine cubic capacity, the number Pi shall be 3.1416.

### **1.11 Supercharging :**

Increasing the weight of the charge of the fuel/air mixture in the combustion chamber (over the weight induced by normal atmospheric pressure, ram effect and dynamic effects in the intake and/or exhaust system) by any means whatsoever. The injection of fuel under pressure is not considered to be supercharging.

**1.12 Cockpit :**

The volume which accommodates the driver.

**1.13 Sprung suspension :**

The means whereby all complete wheels are suspended from the body/chassis unit by a spring medium.

**1.14 Survival cell :**

A continuous closed structure containing the fuel tank and the cockpit.

**1.15 Camera :**

Television cameras the dimensions of which are defined in drawing 6.

**1.16 Camera housing :**

A device which is identical in shape and weight to a camera and which is supplied by the relevant competitor for fitting to his car in lieu of a camera.

**1.17 Cockpit padding :**

Non-structural parts placed within the cockpit for the sole purpose of improving driver comfort and safety. All such material must be quickly removable without the use of tools.

**1.18 Brake caliper :**

All parts of the braking system outside the survival cell, other than brake discs, brake pads, caliper pistons, brake hoses and fittings, which are stressed when subjected to the braking pressure. Bolts or studs which are used for attachment are not considered to be part of the braking system.

**1.19 Electronically controlled :**

Any command system or process that utilises semi-conductor or thermionic technology.

**1.20 Kinetic Energy Recovery System (KERS) :**

A system that is designed to recover kinetic energy from the car during braking, store that energy and make it available to propel the car.

**1.21 Open and closed sections :**

A section will be considered closed if it is fully complete within the dimensioned boundary to which it is referenced, if it is not it will be considered open.

## **ARTICLE 2 : GENERAL PRINCIPLES**

### **2.1 Role of the FIA :**

The following technical regulations for Formula One cars are issued by the FIA.

### **2.2 Amendments to the regulations :**

Changes to these regulations may only be made in accordance with the provisions of [the Code The 2009 Concorde Agreement](#).

### **2.3 Dangerous construction :**

The stewards of the meeting may exclude a vehicle whose construction is deemed to be dangerous.

### **2.4 Compliance with the regulations :**

Automobiles must comply with these regulations in their entirety at all times during an Event.

Should a competitor introduce a new design or system or feel that any aspect of these regulations is unclear, clarification may be sought from the FIA Formula One Technical Department. If clarification relates to any new design or system, correspondence must include:

- A full description of the design or system.
- Drawings or schematics where appropriate.
- The competitor's opinion concerning the immediate implications on other parts of the car of any proposed new design.
- The competitor's opinion concerning any possible long term consequences or new developments which may come from using any such new designs or systems.
- The precise way or ways in which the competitor feels the new design or system will enhance the performance of the car.

### **2.5 New systems or technologies :**

Any new system, procedure or technology not specifically covered by these regulations, but which is deemed permissible by the FIA Formula One Technical Department, will only be admitted until the end of the Championship during which it is introduced. Following this the Formula One Commission will be asked to review the technology concerned and, if they feel it adds no value to Formula One in general, it will be specifically prohibited.

Any team whose technology is prohibited in this way will then be required to publish full technical details of the relevant system or procedure.

### **2.6 Measurements :**

All measurements must be made while the car is stationary on a flat horizontal surface.

### **2.7 Duty of Competitor :**

It is the duty of each competitor to satisfy the FIA technical delegate and the stewards of the meeting that his automobile complies with these regulations in their entirety at all times during an Event.

The design of the car, its components and systems shall, with the exception of safety features, demonstrate their compliance with these regulations by means of physical inspection of hardware or materials. No mechanical design may rely upon software inspection as a means of ensuring its compliance.



## **ARTICLE 3 : BODYWORK AND DIMENSIONS**

One of the purposes of the regulations under Article 3 below is to minimize the detrimental effect that the wake of a car may have on a following car.

Furthermore, infinite precision can be assumed on certain dimensions provided it is clear that such an assumption is not being made in order to circumvent or subvert the intention of the relevant regulation.

For illustrations refer to drawings 1A-17A in the Appendix to these regulations.

### **3.1 Wheel centre line :**

The centre line of any wheel shall be deemed to be half way between two straight edges, perpendicular to the surface on which the car is standing, placed against opposite sides of the complete wheel at the centre of the tyre tread.

### **3.2 Height measurements :**

All height measurements will be taken normal to and from the reference plane.

### **3.3 Overall width :**

The overall width of the car, excluding tyres, must not exceed 1800mm with the steered wheels in the straight ahead position.

### **3.4 Width ahead of the rear wheel centre line :**

**3.4.1** Bodywork width between the front and the rear wheel centre lines must not exceed 1400mm.

**3.4.2** In order to prevent tyre damage to other cars, any bodywork outboard of the most inboard part of the bodywork used to define the area required by Article 3.7.5, and which is more than 450mm ahead of the front wheel centre line, must be at least 10mm thick (being the minimum distance when measured normal to the surface in any direction) with a 5mm radius applied to all extremities.

**3.4.3** In order to avoid the spread of debris on the track following an accident, the outer skins of the front wing endplates and any turning vanes in the vicinity of the front wheels (and any similarly vulnerable bodywork parts in this area), must be made predominantly from materials which are included for the specific purpose of containing debris.

The FIA must be satisfied that all such parts are constructed in order to achieve the stated objective.

### **3.5 Width behind the rear wheel centre line :**

**3.5.1** The width of bodywork behind the rear wheel centre line and less than 150mm above the reference plane must not exceed 1000mm.

**3.5.2** The width of bodywork behind the rear wheel centre line and more than 150mm above the reference plane must not exceed 750mm.

### **3.6 Overall height :**

No part of the bodywork may be more than 950mm above the reference plane.

### **3.7 Front bodywork :**

**3.7.1** All bodywork situated forward of a point lying 330mm behind the front wheel centre line, and more than 250mm from the car centre line, must be no less than 75mm and no more than 275mm above the reference plane.

- 3.7.2** Any horizontal section taken through bodywork located forward of a point lying 450mm forward of the front wheel centre line, less than 250mm from the car centre line, and between 125mm and 200mm above the reference plane, may only contain two closed symmetrical sections with a maximum total area of 5000mm<sup>2</sup>. The thickness of each section may not exceed 25mm when measured perpendicular to the car centre line.

Once fully defined, the sections at 125mm above the reference plane must be projected vertically to join the profile required by Article 3.7.3. A radius no greater than 10mm may be used where these sections join.

- 3.7.3** Forward of a point lying 450mm ahead of the front wheel centre line and less than 250mm from the car centre line and less than 125mm above the reference plane, only one single section may be contained within any longitudinal vertical cross section parallel to the car centre line.

Furthermore, with the exception of local changes of section where the bodywork defined in Article 3.7.2 attaches to this section, the profile, incidence and position of this section must conform to drawing 7. This section may not contain any closed channel the effect of which is to duct air directly or indirectly to or from the external air stream for any purpose other than data acquisition.

- 3.7.4** In the area bounded by lines between 450mm and 1000mm ahead of the front wheel centre line, 250mm and 400mm from the car centre line and between 75mm and 275mm above the reference plane, the projected area of all bodywork onto the longitudinal centre plane of the car must be no more than 20,000mm<sup>2</sup>.

- 3.7.5** Ahead of the front wheel centre line and between 750mm and 840mm from the car centre line there must be bodywork with a projected area of no less than 95,000mm<sup>2</sup> in side view.

- 3.7.6** Ahead of the front wheel centre line and between 840mm and 900mm from the car centre line there must be bodywork with a projected area of no less than 28,000mm<sup>2</sup> in plan view. Furthermore, when viewed from underneath, the bodywork in this area must form one continuous surface which may not be more than 100mm above the reference plane.

- 3.7.7** Any longitudinal vertical cross section taken through bodywork ahead of the front wheel centre line and between 840mm and 900mm from the car centre line must contain an area no greater than 15,000mm<sup>2</sup>.

- 3.7.8** Only a single section, which must be open, may be contained within any longitudinal vertical cross section taken parallel to the car centre line forward of a point 150mm ahead of the front wheel centre line, less than 250mm from the car centre line and more than 125mm above the reference plane.

Any cameras or camera housings approved by the FIA in addition to a single inlet aperture for the purpose of driver cooling (such aperture having a maximum projected surface area of 1500mm<sup>2</sup> and being situated forward of the section referred to in Article 15.4.3) will be exempt from the above.

- 3.7.9** With the exception of an optional, single piece, non-structural fairing of prescribed laminate (whose precise lay-up may be found in the Appendix to the regulations) which may not be more than 625mm above the reference plane at any point, no bodywork situated more than 1950mm forward of rear face of the cockpit entry template may be more than 550mm above the reference plane.

### **3.8 Bodywork in front of the rear wheels :**

- 3.8.1** Other than the rear view mirrors (including their mountings), each with a maximum area of 12000mm<sup>2</sup> and 14000 mm<sup>2</sup> when viewed from directly above or directly from the side respectively, no bodywork situated more than 330mm behind the front wheel centre line and more than 330mm forward of the rear wheel centre line, which is more than 600mm above the reference plane, may be more than 300mm from the car centre line.
- 3.8.2** No bodywork between the rear wheel centre line and a line 800mm forward of the rear wheel centre line, which is more than 375mm from the car centre line, may be more than 500mm above the reference plane.
- 3.8.3** No bodywork between the rear wheel centre line and a line 400mm forward of the rear wheel centre line, which is more than 375mm from the car centre line, may be more than 300mm above the reference plane.
- 3.8.4** Any vertical cross section of bodywork normal to the car centre line situated in the volumes defined below must form one tangent continuous curve on its external surface. This tangent continuous curve may not contain any radius less than 75mm :
- a) The volume between 50mm forward of the rear wheel centre line and 300mm rearward of the rear face of the cockpit entry template, which is more than 25mm from the car centre line and more than 100mm above the reference plane.
  - b) The volume between 300mm rearward of the rear face of the cockpit entry template and the rear face of the cockpit entry template, which is more than 125mm from the car centre line and more than 100mm above the reference plane.
  - c) The volume between the rear face of the cockpit entry template and 450mm forward of the rear face of the cockpit entry template, which is more than 350mm from the car centre line and more than 100mm above the reference plane.
  - d) The volume between the rear face of the cockpit entry template and 450mm forward of the rear face of the cockpit entry template, which is more than 125mm from the car centre line and more than 675mm above the reference plane.

The surfaces lying within these volumes, which are situated more than 55mm forward of the rear wheel centre line, must not contain any apertures (other than those permitted by Article 3.8.5) or contain any vertical surfaces which lie normal to the car centre line.

- 3.8.5** Once the relevant bodywork surfaces are defined in accordance with Article 3.8.4, apertures, any of which may adjoin or overlap each other, may be added for the following purposes only:
- a) Single apertures either side of the car centre line for the purpose of exhaust exits. These apertures may have a combined area of no more than 50,000mm<sup>2</sup> when projected onto the surface itself. No point on an aperture may be more than 350mm from any other point on the aperture.
  - b) Apertures either side of the car centre line for the purpose of allowing suspension members and driveshafts to protrude through the bodywork. Only one aperture may be added for each suspension member and no such aperture may have an area greater than 12,000 mm<sup>2</sup> when projected onto the surface itself. No point on an aperture may be more than 200mm from any other point on the aperture.
- 3.8.6** The impact absorbing structures defined by Article 15.5.2 must be fully enclosed by bodywork, such that no part of the impact structure is in contact with the external air flow. When cut by a longitudinal vertical plane, the bodywork enclosing these impact structures must not form closed sections in the region between 450mm and 875mm forward of the rear edge of the cockpit template.
- 3.8.7** With the exception of a transparent windscreen, antenna or pitot tubes, no bodywork higher than the top of the front roll structure will be permitted forward of it.

### **3.9 Bodywork between the rear wheels :**

- 3.9.1** No bodywork situated between 50mm and 330mm forward of the rear wheel centre line may be more than 730mm above the reference plane.
- 3.9.2** No bodywork situated between 50mm forward of the rear wheel centre line and 150mm behind the rear wheel centre line, and which is between 75mm and 355mm from the car centre line, may be located between 400mm and 730mm above the reference plane.

### **3.10 Bodywork behind the rear wheel centre line :**

- 3.10.1** Any bodywork more than 150mm behind the rear wheel centre line which is between 150mm and 730mm above the reference plane, and between 75mm and 355mm from the car centre line, must lie in an area when viewed from the side of the car that is situated between 150mm and 350mm behind the rear wheel centre line and between 300mm and 400mm above the reference plane. When viewed from the side of the car no longitudinal vertical cross section may have more than one section in this area. Furthermore, no part of this section in contact with the external air stream may have a local concave radius of curvature smaller than 100mm.

Once this section is defined, 'gurney' type trim tabs may be fitted to the trailing edge. When measured in any longitudinal cross section no dimension of any such trim tab may exceed 20mm.

- 3.10.2** Other than the bodywork defined in Article 3.10.1, any bodywork behind a point lying 50mm forward of the rear wheel centre line which is more than 730mm above the reference plane, and less than 355mm from the car centre line, must lie in an area when viewed from the side of the car that is situated between the rear wheel centre line and a point 350mm behind it.

With the exception of minimal parts solely associated with adjustment of the section in accordance with Article 3.18 :

- When viewed from the side of the car, no longitudinal vertical cross section may have more than two sections in this area, each of which must be closed.
- No part of these longitudinal cross sections in contact with the external air stream may have a local concave radius of curvature smaller than 100mm.

Once the rearmost and uppermost section is defined, 'gurney' type trim tabs may be fitted to the trailing edge. When measured in any longitudinal vertical cross section no dimension of any such trim tab may exceed 20mm.

The chord of the rearmost and uppermost closed section must always be smaller than the chord of the lowermost section at the same lateral station.

Furthermore, the distance between adjacent sections at any longitudinal vertical plane must lie between 10mm and 15mm at their closest position, except, in accordance with Article 3.18, when this distance must lie between 10mm and 50mm.

- 3.10.3** In order to ensure that the individual profiles and the relationship between these two sections can only change whilst the car is in motion in accordance with Article 3.18, they must be bridged by means of pairs of rigid impervious supports arranged such that no part of the trailing edge of the forward section may be more than 200mm laterally from a pair of supports. These pairs of supports must :

- Be located no more than 355mm from the car centre line.
- Fully enclose each complete section such that their inner profiles match that of each section. With the exception of minimal local changes where the two sections are adjacent to each other, their outer profiles must be offset from the inner profiles by between 8mm and 30mm and may not incorporate any radius smaller than 10mm ('gurney' type trim tabs may however be fitted between the supports).

- Be aligned as a pair so as to provide a bearing across their full thickness and along a profile length of at least 10mm when the distance between the two sections is at its closest position.
- Not be recessed into the wing profiles (where a recess is defined as a reduction in section at a rate greater than 45° with respect to a lateral axis).
- Be arranged so that any curvature occurs only in a horizontal plane (other than when this bodywork is adjusted in accordance with Article 3.18).
- Be between 2mm and 5mm thick.
- Be rigidly fixed to their respective sections.
- Be constructed from a material with modulus greater than 50GPa.

These supports will be ignored when assessing whether the car is in compliance with Articles 3.6, 3.9.2, 3.10.1, 3.10.2, 3.10.4 and 3.10.6.

- 3.10.4** No part of the car between 75mm and 355mm from the car centre line may be more than 350mm behind the rear wheel centre line.
- 3.10.5** Any parts of the car less than 75mm from the car centre line and more than 500mm behind the rear wheel centre line must be situated between 200mm and 400mm above the reference plane.
- 3.10.6** No part of the car less than 75mm from the car centre line and more than 350mm behind the rear wheel centre line may be more than 400mm above the reference plane.
- 3.10.7** No part of the car more than 375mm from the car centre line may be more than 350mm behind the rear wheel centre line.
- 3.10.8** In side view, the projected area of any bodywork lying between 300mm and 950mm above the reference plane and between the rear wheel centre line and a point 600mm behind it and more than 355mm from the car centre line must be greater than 330000mm<sup>2</sup>.
- 3.10.9** Any horizontal section between 600mm and 730mm above the reference plane, taken through bodywork located rearward of a point lying 50mm forward of the rear wheel centre line and less than 75mm from the car centre line, may contain no more than two closed symmetrical sections with a maximum total area of 5000mm<sup>2</sup>. The thickness of each section may not exceed 25mm when measured perpendicular to the car centre line.

Once fully defined, the section at 725mm above the reference plane may be extruded upwards to join the sections defined in Article 3.10.2. A fillet radius no greater than 10mm may be used where these sections join.

### **3.11 Bodywork around the front wheels :**

- 3.11.1** With the exception of the air ducts described in Article 11.4 and the mirrors described in Article 3.8.1, in plan view, there must be no bodywork in the area formed by the intersection of the following lines :
- A longitudinal line parallel to and 900mm from the car centre line.
  - A transverse line 450mm forward of the front wheel centre line.
  - A diagonal line from 450mm forward of the front wheel centre line and 400mm from the car centre line to 750mm forward of the front wheel centre line and 250mm from the car centre line.
  - A transverse line 750mm forward of the front wheel centre line.
  - A longitudinal line parallel to and 165mm from the car centre line.

- A diagonal line running forwards and inwards, from a point 875mm forward of the rear face of the cockpit entry template and 240mm from the car centre line, at an angle of 4.5° to the car centre line.
- A diagonal line from 875mm forward of the rear face of the cockpit entry template and 240mm from the car centre line to 625mm forward of the rear face of the cockpit entry template and 415mm from the car centre line.
- A transverse line 625mm forward of the rear face of the cockpit entry template.

For reference this area is shown in drawing 17A in the Appendix to these regulations.

- 3.11.2** With the exception of the air ducts described in Article 11.4, in side view, there must be no bodywork in the area formed by two vertical lines, one 325mm behind the front wheel centre line, one 450mm ahead of the front wheel centre line, one diagonal line intersecting the vertical lines at 100mm and 200mm above the reference plane respectively, and one horizontal line on the reference plane.

### **3.12 Bodywork facing the ground :**

- 3.12.1** With the skid block referred to in Article 3.13 removed all sprung parts of the car situated from 330mm behind the front wheel centre line to the rear wheel centre line, and which are visible from underneath, must form surfaces which lie on one of two parallel planes, the reference plane or the step plane. This does not apply to any parts of rear view mirrors which are visible, provided each of these areas does not exceed 12000mm<sup>2</sup> when projected to a horizontal plane above the car, or to any parts of the panels referred to in Article 15.4.7 and 15.4.8.

The step plane must be 50mm above the reference plane.

- 3.12.2** Additionally, the surface formed by all parts lying on the reference plane must :

- Cover the area which is bounded by two transversal lines, one 330mm behind the front wheel centre line and the other on the rear wheel centre line, and two longitudinal lines 150mm either side of the car centre line.
- Have a maximum width of 500mm.
- Be symmetrical about the car centre line.
- Have a 50mm radius (+/-2mm) on each front corner when viewed from directly beneath the car, this being applied after the surface has been defined.

- 3.12.3** The surface lying on the reference plane must be joined around its periphery to the surfaces lying on the step plane by a vertical transition. If there is no surface visible on the step plane vertically above any point around the periphery of the reference plane, this transition is not necessary.

- 3.12.4** The boundaries of the surfaces lying on the reference and step planes may be curved upwards with maximum radii of 25mm and 50mm respectively. Where the vertical transition meets the surfaces on the step plane a radius, no greater than 25mm, is permitted.

A radius in this context will be considered as an arc applied perpendicular to the boundary and tangential to both surfaces.

The surface lying on the reference plane, the surfaces lying on the step plane, the vertical transitions between them and any surfaces rearward of the surfaces lying on the reference or step planes, must first be fully defined before any radius can be applied or the skid block fitted. Any radius applied is still considered part of the relevant surface.

- 3.12.5** All parts lying on the reference and step planes, in addition to the transition between the two planes, must produce uniform, solid, hard, continuous, rigid (no degree of freedom in relation to the body/chassis unit), impervious surfaces under all circumstances.

Forward of a line 450mm forward of the rear face of the cockpit entry template, fully enclosed holes are permitted in the surfaces lying on the reference and step planes provided no part of the car is visible through them when viewed from directly below. This does not apply to any parts of rear view mirrors which are visible, provided each of these areas does not exceed 12000mm<sup>2</sup> when projected to a horizontal plane above the car, or to any parts of the panels referred to in Article 15.4.7.

**3.12.6** To help overcome any possible manufacturing problems, and not to permit any design which may contravene any part of these regulations, dimensional tolerances are permitted on bodywork situated between a point lying 330mm behind the front wheel centre line and the rear wheel centre line. A vertical tolerance of +/- 3mm is permissible across the surfaces lying on the reference and step planes and a horizontal tolerance of 3mm is permitted when assessing whether a surface is visible from beneath the car.

**3.12.7** No bodywork which is visible from beneath the car and which lies between the rear wheel centre line and a point 350mm rearward of it may be more than 125mm above the reference plane. With the exception of the aperture described below, any intersection of the surfaces in this area with a lateral or longitudinal vertical plane should form one continuous line which is visible from beneath the car.

An aperture for the purpose of allowing access for the device referred to in Article 5.18 is permitted in this surface. However, no such aperture may have an area greater than 3500mm<sup>2</sup> when projected onto the surface itself and no point on the aperture may be more than 100mm from any other point on the aperture.

Additionally, any bodywork in this area must produce uniform, solid, hard, continuous, rigid (no degree of freedom in relation to the body/chassis unit), impervious surfaces under all circumstances).

**3.12.8** All sprung parts of the car situated behind the rear wheel centre line, which are visible from underneath and are more than 250mm from the car centre line, must be at least 50mm above the reference plane.

**3.12.9** In an area lying 450mm or less from the car centre line, and from 450mm forward of the rear face of the cockpit entry template to 350mm rearward of the rear wheel centre line, any intersection of any bodywork visible from beneath the car with a lateral or longitudinal vertical plane should form one continuous line which is visible from beneath the car. When assessing the compliance of bodywork surfaces in this area the aperture referred to in Article 3.12.7 need not be considered.

**3.12.10** In an area lying 650mm or less from the car centre line, and from 450mm forward of the rear face of the cockpit entry template to 350mm forward of the rear wheel centre line, any intersection of any bodywork visible from beneath the car with a lateral or longitudinal vertical plane should form one continuous line which is visible from beneath the car.

**3.12.11** Compliance with Article 3.12 must be demonstrated with the panels referred to in Articles 15.4.7 and 15.4.8 and all unsprung parts of the car removed.

### **3.13 Skid block :**

**3.13.1** Beneath the surface formed by all parts lying on the reference plane, a rectangular skid block, with a 50mm radius (+/-2mm) on each front corner, must be fitted. This skid block may comprise no more than three pieces, the forward one of which may not be any less than 1000mm in length, but must :

- a) Extend longitudinally from a point lying 330mm behind the front wheel centre line to the rear wheel centre line.
- b) Be made from an homogeneous material with a specific gravity between 1.3 and 1.45.
- c) Have a width of 300mm with a tolerance of +/- 2mm.

- d) Have a thickness of 10mm with a tolerance of +/- 1mm.
- e) Have a uniform thickness when new.
- f) Have no holes or cut outs other than those necessary to fit the fasteners permitted by 3.13.2 or those holes specifically mentioned in g) below.
- g) Have seven precisely placed holes the positions of which are detailed in drawing 1. In order to establish the conformity of the skid block after use, its thickness will only be measured in the four 50mm diameter holes and the two forward 80mm diameter holes.  
Four further 10mm diameter holes are permitted provided their sole purpose is to allow access to the bolts which secure the Accident Data Recorder to the survival cell.
- h) Be fixed symmetrically about the car centre line in such a way that no air may pass between it and the surface formed by the parts lying on the reference plane.

**3.13.2** Fasteners used to attach the skid block to the car must :

- a) Have a total area no greater than 40000mm<sup>2</sup> when viewed from directly beneath the car.
- b) Be no greater than 2000mm<sup>2</sup> in area individually when viewed from directly beneath the car.
- c) Be fitted in order that their entire lower surfaces are visible from directly beneath the car.

When the skid block is new, ten of the fasteners may be flush with its lower surface but the remainder may be no more than 8mm below the reference plane.

**3.13.3** The lower edge of the periphery of the skid block may be chamfered at an angle of 30° to a depth of 8mm, the trailing edge however may be chamfered over a distance of 200mm to a depth of 8mm.

**3.14 Overhangs :**

**3.14.1** No part of the car may be more than 600mm behind the rear wheel centre line or more than 1200mm in front of the front wheel centre line.

**3.14.2** No part of the bodywork more than 200mm from the car centre line may be more than 1000mm in front of the front wheel centre line.

**3.14.3** All overhang measurements will be taken parallel to the reference plane.

**3.15 Aerodynamic influence :**

With the exception of the driver adjustable bodywork described in Article 3.18 (in addition to minimal parts solely associated with its actuation) and the ducts described in Article 11.4, any specific part of the car influencing its aerodynamic performance :

- Must comply with the rules relating to bodywork.
- Must be rigidly secured to the entirely sprung part of the car (rigidly secured means not having any degree of freedom).
- Must remain immobile in relation to the sprung part of the car.

Any device or construction that is designed to bridge the gap between the sprung part of the car and the ground is prohibited under all circumstances.

No part having an aerodynamic influence and no part of the bodywork, with the exception of the skid block in 3.13 above, may under any circumstances be located below the reference plane.



With the exception of the parts necessary for the adjustment described in Article 3.18, any car system, device or procedure which uses driver movement as a means of altering the aerodynamic characteristics of the car is prohibited.

### **3.16 Upper bodywork :**

- 3.16.1** With the exception of the opening described in Article 3.16.3, when viewed from the side, the car must have bodywork in the area bounded by four lines. One vertical 1330mm forward of the rear wheel centre line, one horizontal 550mm above the reference plane, one horizontal 925mm above the reference plane and one diagonal which intersects the 925mm horizontal at a point 1000mm forward of the rear wheel centre line and the 550mm horizontal at a point lying 50mm forward of the rear wheel centre line.

Bodywork within this area must be arranged symmetrically about the car centre line and, when measured 200mm vertically below the diagonal boundary line, must have minimum widths of 150mm and 50mm respectively at points lying 1000mm and 50mm forward of the rear wheel centre line. This bodywork must lie on or outside the boundary defined by a linear taper between these minimum widths.

- 3.16.2** Bodywork lying vertically above the upper boundary as defined in 3.16.1 may be no wider than 125mm and must be arranged symmetrically about the car centre line.
- 3.16.3** In order that a car may be lifted quickly in the event of it stopping on the circuit, the principal rollover structure must incorporate a clearly visible unobstructed opening designed to permit a strap, whose section measures 60mm x 30mm, to pass through it.

### **3.17 Bodywork flexibility :**

- 3.17.1** Bodywork may deflect no more than 20mm vertically when a 1000N load is applied vertically to it 800mm forward of the front wheel centre line and 795mm from the car centre line. The load will be applied in a downward direction using a 50mm diameter ram to the centre of area of an adapter measuring 300mm x 150mm, the 300mm length having been positioned parallel to the car centre line. Teams must supply the adapter when such a test is deemed necessary.

The deflection will be measured along the loading axis at the bottom of the bodywork at this point and relative to the reference plane.

- 3.17.2** Bodywork may deflect no more than 10mm vertically when a 500N load is applied vertically to it 450mm forward of the rear wheel centre line and 650mm from the car centre line. The load will be applied in a downward direction using a 50mm diameter ram and an adapter of the same size. Teams must supply the latter when such a test is deemed necessary.
- 3.17.3** Bodywork may deflect by no more than one degree horizontally when a load of 1000N is applied simultaneously to its extremities in a rearward direction 925mm above the reference plane and 20mm forward of the forward edge of the rear wing endplate.
- 3.17.4** Bodywork may deflect no more than 2mm vertically when a 500N load is applied simultaneously to each side of it 200mm behind the rear wheel centre line, 325mm from the car centre line and 970mm above the reference plane. The deflection will be measured at the outer extremities of the bodywork at a point 345mm behind the rear wheel centre line.

The load will be applied in a downward direction through pads measuring 200mm x 100mm which conform to the shape of the bodywork beneath them, and with their uppermost horizontal surface 970mm above the reference plane. The load will be applied to the centre of area of the pads. Teams must supply the latter when such a test is deemed necessary.

**3.17.5** Bodywork may deflect no more than 5mm vertically when a 2000N load is applied vertically to it at three different points which lie on the car centre line and 100mm either side of it. Each of these loads will be applied in an upward direction at a point 380mm rearward of the front wheel centre line using a 50mm diameter ram in the two outer locations and a 70mm diameter ram on the car centre line. Stays or structures between the front of the bodywork lying on the reference plane and the survival cell may be present for this test, provided they are completely rigid and have no system or mechanism which allows non-linear deflection during any part of the test.

Furthermore, the bodywork being tested in this area may not include any component which is capable of allowing more than the permitted amount of deflection under the test load (including any linear deflection above the test load), such components could include, but are not limited to :

- a) Joints, bearings pivots or any other form of articulation.
- b) Dampers, hydraulics or any form of time dependent component or structure.
- c) Buckling members or any component or design which may have any non-linear characteristics.
- d) Any parts which may systematically or routinely exhibit permanent deformation.

**3.17.6** The uppermost aerofoil element lying behind the rear wheel centre line may deflect no more than 5mm horizontally when a 500N load is applied horizontally. The load will be applied 950mm above the reference plane at three separate points which lie on the car centre line and 190mm either side of it. The loads will be applied in a rearward direction using a suitable 25mm wide adapter which must be supplied by the relevant team.

**3.17.7** The forward-most aerofoil element lying behind the rear wheel centre line and which lies more than 730mm above the reference plane may deflect no more than 2mm vertically when a 200N load is applied vertically. The load will be applied in line with the trailing edge of the element at any point across its width. The loads will be applied using a suitable adapter, supplied by the relevant team, which :

- May be no more than 50mm wide.
- Which extends no more than 10mm forward of the trailing edge.
- Incorporates an 8mm female thread in the underside.

**3.17.8** In order to ensure that the requirements of Article 3.15 are respected, the FIA reserves the right to introduce further load/deflection tests on any part of the bodywork which appears to be (or is suspected of), moving whilst the car is in motion.

### **3.18 Driver adjustable bodywork :**

**3.18.1** The incidence of the rearmost and uppermost closed section described in Article 3.10.2 may be varied whilst the car is in motion provided :

- It comprises only one component that must be symmetrically arranged about the car centre line with a minimum width of 708mm.
- With the exception of minimal parts solely associated with adjustment of the section, no parts of the section in contact with the external airstream may be located any more than 355mm from of the car centre line.
- With the exception of any minimal parts solely associated with adjustment of the rearmost and uppermost section, two closed sections are used in the area described in Article 3.10.2.
- Any such variation of incidence maintains compliance with all of the bodywork regulations.

- It cannot be used to change the geometry of any duct, either directly or indirectly, other than the change to the distance between adjacent sections permitted by Article 3.10.2.
- When viewed from the side of the car at any longitudinal vertical cross section, the physical point of rotation of the rearmost and uppermost closed section must be fixed and located no more than 20mm below the upper extremity and no more than 20mm forward of the rear extremity of the area described in Article 3.10.2 at all times.
- The design is such that failure of the system will result in the uppermost closed section returning to the normal high incidence position.
- Any alteration of the incidence of the uppermost closed section may only be commanded by direct driver input and controlled using the control electronics specified in Article 8.2.

## **ARTICLE 4 : WEIGHT**

### **4.1 Minimum weight :**

The weight of the car, without fuel, must not be less than 640kg at all times during the Event.

If, when required for checking, a car is not already fitted with dry-weather tyres, it will be weighed on a set of dry-weather tyres selected by the FIA technical delegate.

### **4.2 Weight distribution :**

For 2012 and 2013 only, the weight applied on the front and rear wheels must not be less than 291kg and 342kg respectively at all times during the qualifying practice session.

If, when required for checking, a car is not already fitted with dry-weather tyres, it will be weighed on a set of dry-weather tyres selected by the FIA technical delegate.

### **4.3 Weight of tyres :**

The weight limits specified in Articles 4.1 and 4.2 will be adjusted according to any differences (rounded up to the nearest 1kg) between the total set and individual axle set weights respectively of the 2010 and 2011 dry-weather tyres.

### **4.4 Ballast :**

Ballast can be used provided it is secured in such a way that tools are required for its removal. It must be possible to fix seals if deemed necessary by the FIA technical delegate.

### **4.5 Adding during the race :**

With the exception of compressed gases, no substance may be added to the car during the race. If it becomes necessary to replace any part of the car during the race, the new part must not weigh any more than the original part.

## **ARTICLE 5 : ENGINES AND KINETIC ENERGY RECOVERY SYSTEMS**

### **5.1 Engine specification :**

- 5.1.1 Only 4-stroke engines with reciprocating pistons are permitted.
- 5.1.2 Engine capacity must not exceed 2400cc.
- 5.1.3 Crankshaft rotational speed must not exceed 18,000rpm.
- 5.1.4 Supercharging is forbidden.
- 5.1.5 All engines must have 8 cylinders arranged in a 90° "V" configuration and the normal section of each cylinder must be circular.
- 5.1.6 Engines must have two inlet and two exhaust valves per cylinder.

Only reciprocating poppet valves are permitted.

The sealing interface between the moving valve component and the stationary engine component must be circular.

### **5.2 Other means of propulsion :**

- 5.2.1 The use of any device, other than the 2.4 litre, four stroke engine described in 5.1 above and one KERS, to power the car, is not permitted.
- 5.2.2 With the exception of one fully charged KERS, the total amount of recoverable energy stored on the car must not exceed 300kJ. Any which may be recovered at a rate greater than 2kW must not exceed 20kJ.
- 5.2.3 The maximum power, in or out, of any KERS must not exceed 60kW.  
Energy released from the KERS may not exceed 400kJ in any one lap.  
Measurements will be taken at the connection to the rear wheel drivetrain.
- 5.2.4 The amount of stored energy in any KERS may not be increased whilst the car is stationary during a race pit stop.  
Release of power from any such system must remain under the complete control of the driver at all times the car is on the track.
- 5.2.5 Cars must be fitted with homologated sensors which provide all necessary signals to the SDR in order to verify the requirements above are being respected.

### **5.3 Engine dimensions :**

- 5.3.1 Cylinder bore diameter may not exceed 98mm.
- 5.3.2 Cylinder spacing must be fixed at 106.5mm (+/- 0.2mm).
- 5.3.3 The crankshaft centre line must not be less than 58mm above the reference plane.

### **5.4 Weight and centre of gravity :**

- 5.4.1 The overall weight of the engine must be a minimum of 95kg.
- 5.4.2 The centre of gravity of the engine may not lie less than 165mm above the reference plane.
- 5.4.3 The longitudinal and lateral position of the centre of gravity of the engine must fall within a region that is the geometric centre of the engine, +/- 50mm. The geometric centre of the engine in a lateral sense will be considered to lie on the centre of the crankshaft and at the mid point between the centres of the forward and rear most cylinder bores longitudinally.
- 5.4.4 When establishing conformity with Articles 5.4.1, 5.4.2, 5.4.3 and Appendix 4 of the F1 Sporting Regulations, the homologated engine will include the intake system up to and including the air filter, fuel rail and injectors, ignition coils, engine mounted sensors and wiring, alternator, coolant pumps and oil pumps.

**5.4.5** When establishing conformity with Article 5.4, the engine will not include :

- Clutch and clutch actuation system.
- Flywheel.
- Electronic control units or any associated devices containing programmable semiconductors.
- The alternator regulator.
- Liquids.
- Exhaust manifolds.
- Heat shields.
- Oil tanks, catch tanks or any breather system connected to them.
- Studs used to mount the engine to the chassis or gearbox.
- Water system accumulators.
- Heat exchangers.
- Hydraulic system (e.g. pumps, accumulators, manifolds, servo-valves, solenoids, actuators) except servo-valve and actuator for engine throttle control.
- Fuel pumps nor any component not mounted on the engine when fitted to the car.
- Any ancillary equipment associated with the engine valve air system, such as hoses, regulators, reservoirs or compressors.

Furthermore, any parts which are not ordinarily part of an engine will not be included when assessing its weight. Examples of this could be, but are not limited to :

- Wiring harnesses having only a partial association with engine actuators or sensors.
- A bell housing designed to be integral with the engine crankcase.
- Top engine mountings designed higher than necessary with integral webs or struts. The centre of any engine mounting which is part of a cam cover should not be any more than 100mm above a line between the camshaft centres, when measured parallel to it. Any webs integral with the cam cover should not extend further back than the centre of the second cylinder bore.
- Ballast. This is permitted on the engine (subject to the requirements of Article 4.4) but any in excess of 2kg will be removed from the engine before measuring engine weight or centre of gravity height.

## **5.5 Engine torque demand :**

**5.5.1** The only means by which the driver may control the engine torque is via a single chassis mounted foot (accelerator) pedal.

**5.5.2** Designs which allow specific points along the accelerator pedal travel range to be identified by the driver or assist him to hold a position are not permitted.

**5.5.3** The maximum accelerator pedal travel position must correspond to an engine torque demand equal to or greater than the maximum engine torque at the measured engine speed.

The minimum accelerator pedal travel position must correspond to an engine torque demand equal to or lower than 0Nm.

**5.5.4** The accelerator pedal shaping map in the ECU may only be linked to the type of the tyres fitted to the car : one map for use with dry-weather tyres and one map for use with intermediate or wet-weather tyres.

5.5.5 At any given engine speed the driver torque demand map must be monotonically increasing for an increase in accelerator pedal position.

5.5.6 At any given accelerator pedal position and above 5,000rpm, the driver torque demand map must not have a gradient of less than – (minus) 0.030Nm / rpm.

#### **5.6 Engine control :**

5.6.1 The maximum delay allowed, computed from the respective signals as recorded by the ADR or ECU, between the accelerator pedal position input signal and the corresponding output demand being achieved is 50ms.

5.6.2 Teams may be required to demonstrate the accuracy of the engine configurations used by the ECU.

5.6.3 The maximum throttle target map in the ECU may only be used to avoid throttle target oscillations when the change of torque is small for a change of throttle position. It must not be used to artificially reduce the maximum engine torque.

The selection of the maximum throttle target map will be fixed during qualifying and race.

5.6.4 Engine control must not be influenced by clutch position, movement or operation.

5.6.5 The idle speed control target may not exceed 5,000rpm.

5.6.6 Except when anti-stall or idle speed control are active, ignition base offsets may only be applied above 80% throttle and 15,000rpm and for the sole purpose of reducing cylinder pressure for reliability.

5.6.7 A number of engine protections are available in the ECU.

A minimum of nine seconds hold time should be configured for the engine protections enabled during qualifying and race. The configuration of the air tray fire detection and throttle failsafe are exceptionally unrestricted in order to allow each team to achieve the best level of safety.

#### **5.7 Engine high rev limits :**

Engine high rev limits may vary for differing conditions provided all are significantly above the peak of the engine torque curve. However, a lower rev limit may be used when :

- The gearbox is in neutral.
- Stall prevention is active.
- The driver clutch request is greater than 95% of the total available travel of the driver clutch actuation device, used only to protect the engine following a driver error.
- An engine protection is active.
- The bite point finder strategy is active.
- The safety car is deployed or during the formation lap.

Except for the above conditions, ignition, fuelling and throttle may not be used to artificially control the engine speed or alter the engine response in a rev range more than 1,000rpm below the final rev limit.

#### **5.8 Exhaust systems :**

5.8.1 With the exception of incidental leakage through exhaust joints (either into or out of the system), no fluids, other than those which emerge from the engine exhaust ports, may be admitted into the engine exhaust system.

5.8.2 Engine exhaust systems may incorporate no more than two exits, both of which must be rearward facing tailpipes, through which all exhaust gases must pass.

**5.8.3** The last 100mm of any tailpipe must in its entirety :

- a) Form a thin-walled unobstructed right circular cylinder whose internal diameter is no greater than 75mm with its axis at +/-10° to the car centre line when viewed from above the car and between +10° and +30° (tail-up) to the reference plane when viewed from the side of the car. The entire circumference of the exit should lie on a single plane normal to the tailpipe axis and be located at the rearmost extremity of the last 100mm of the tailpipe.
- b) Be located between 250mm and 600mm above the reference plane.
- c) Be located between 200mm and 500mm from the car centre line.
- d) Be positioned in order that the entire circumference of the exit of the tailpipe lies between two vertical planes normal to the car centre line and which lie 500mm and 1200mm forward of the rear wheel centre line.

**5.8.4** Once the exhaust tailpipes, the bodywork required by Article 3.8.4 and any apertures permitted by Article 3.8.5 have been fully defined there must be no bodywork lying within a right circular truncated cone which :

- a) Shares a common axis with that of the last 100mm of the tailpipe.
- b) Has a forward diameter equal to that of each exhaust exit.
- c) Starts at the exit of the tailpipe and extends rearwards as far as the rear wheel centre line.
- d) Has a half-cone angle of 3° such that the cone has its larger diameter at the rear wheel centre line.

Furthermore, there must be a view from above, the side, or any intermediate angle perpendicular to the car centre line, from which the truncated cone is not obscured by any bodywork lying more than 50mm forward of the rear wheel centre line.

## **5.9 Variable geometry systems :**

**5.9.1** Variable geometry inlet systems are not permitted.

**5.9.2** Variable geometry exhaust systems are not permitted.

**5.9.3** Variable valve timing and variable valve lift systems are not permitted.

## **5.10 Fuel systems :**

**5.10.1** The pressure of the fuel supplied to the injectors may not exceed 100bar. Sensors must be fitted which directly measure the pressure of the fuel supplied to the injectors, these signals must be supplied to the FIA data logger.

**5.10.2** Only one fuel injector per cylinder is permitted which must inject directly into the side or the top of the inlet port.

## **5.11 Electrical systems :**

**5.11.1** Ignition is only permitted by means of a single ignition coil and single spark plug per cylinder. The use of plasma, laser or other high frequency ignition techniques is forbidden.

**5.11.2** Only conventional spark plugs that function by high tension electrical discharge across an exposed gap are permitted.

Spark plugs are not subject to the materials restrictions described in Articles 5.16 and 5.17.

**5.11.3** Other than for the specific purpose of powering KERS components, the primary regulated voltage on the car must not exceed 17.0V DC. This voltage is defined as the stabilised output from the on-car charging system.



With the exception of any KERS or capacitor circuitry or coils being used solely to provide ignition, any device with a current requirement greater than 50mA or a power requirement greater than 1W may only be supplied at or below the primary regulated voltage.

Only capacitor discharge ignition systems (those which generate a spark by means of closing a switch which then discharges a capacitor through the primary side of the ignition coil), are permitted to provide a voltage higher than the primary regulated voltage to an ignition coil.

Other than any parts being used to supply a higher voltage to devices such as those described in the previous paragraphs, no device may step up or increase the primary regulated voltage.

#### **5.12 Engine actuators :**

With the following exceptions hydraulic, pneumatic or electronic actuation is forbidden :

- a) Electronic solenoids uniquely for the control of engine fluids.
- b) Components providing controlled pressure air for a pneumatic valve system.
- c) A single actuator to operate the throttle system of the engine.
- d) Any components required as part of a KERS.

#### **5.13 Engine auxiliaries :**

With the exception of electrical fuel pumps engine auxiliaries must be mechanically driven directly from the engine with a fixed speed ratio to the crankshaft.

#### **5.14 Engine intake air :**

**5.14.1** Other than injection of fuel for the normal purpose of combustion in the engine, any device, system, procedure, construction or design the purpose or effect of which is any decrease in the temperature of the engine intake air is forbidden.

**5.14.2** Other than engine sump breather gases and fuel for the normal purpose of combustion in the engine, the spraying of any substance into the engine intake air is forbidden.

#### **5.15 Materials and Construction – Definitions :**

**5.15.1** X Based Alloy (e.g. Ni based alloy) – X must be the most abundant element in the alloy on a %w/w basis. The minimum possible weight percent of the element X must always be greater than the maximum possible of each of the other individual elements present in the alloy.

**5.15.2** X-Y Based Alloy (e.g. Al-Cu based alloy) – X must be the most abundant element as in 5.15.1 above. In addition element Y must be the second highest constituent (%w/w), after X in the alloy. The mean content of Y and all other alloying elements must be used to determine the second highest alloying element (Y).

**5.15.3** Intermetallic Materials (e.g. TiAl, NiAl, FeAl, Cu<sub>3</sub>Au, NiCo) – These are materials where the material is based upon intermetallic phases, i.e. the matrix of the material consists of greater than 50%v/v intermetallic phase(s). An intermetallic phase is a solid solution between two or more metals exhibiting either partly ionic or covalent, or metallic bonding with a long range order, in a narrow range of composition around the stoichiometric proportion.

**5.15.4** Composite Materials – These are materials where a matrix material is reinforced by either a continuous or discontinuous phase. The matrix can be metallic, ceramic, polymeric or glass based. The reinforcement can be present as long fibres (continuous reinforcement); or short fibres, whiskers and particles (discontinuous reinforcement).

**5.15.5** Metal Matrix Composites (MMC's) – These are composite materials with a metallic matrix containing a phase of greater than 2%v/v which is not soluble in the liquid phase of the metallic matrix.

**5.15.6** Ceramic Materials (e.g. Al<sub>2</sub>O<sub>3</sub>, SiC, B<sub>4</sub>C, Ti<sub>5</sub>Si<sub>3</sub>, SiO<sub>2</sub>, Si<sub>3</sub>N<sub>4</sub>) – These are inorganic, non metallic solids.

## **5.16 Materials and construction – General :**

- 5.16.1** Unless explicitly permitted for a specific engine component, the following materials may not be used anywhere on the engine :
- a) Magnesium based alloys.
  - b) Metal Matrix Composites (MMC's).
  - c) Intermetallic materials.
  - d) Alloys containing more than 5% by weight of Beryllium, Iridium or Rhenium.
- 5.16.2** Coatings are free provided the total coating thickness does not exceed 25% of the section thickness of the underlying base material in all axes. In all cases the relevant coating must not exceed 0.8mm.

## **5.17 Materials and construction – Components :**

- 5.17.1** Pistons must be manufactured from an aluminium alloy which is either Al-Si ; Al-Cu ; Al-Mg or Al-Zn based.
- 5.17.2** Piston pins must be manufactured from an iron based alloy and must be machined from a single piece of material.
- 5.17.3** Connecting rods must be manufactured from iron or titanium based alloys and must be machined from a single piece of material with no welded or joined assemblies (other than a bolted big end cap or an interfered small end bush).
- 5.17.4** Crankshafts must be manufactured from an iron based alloy.  
No welding is permitted between the front and rear main bearing journals.  
No material with a density exceeding 19,000kg/m<sup>3</sup> may be assembled to the crankshaft.
- 5.17.5** Camshafts must be manufactured from an iron based alloy.  
Each camshaft and lobes must be machined from a single piece of material.  
No welding is allowed between the front and rear bearing journals.
- 5.17.6** Valves must be manufactured from alloys based on Iron, Nickel, Cobalt or Titanium.  
Hollow structures cooled by sodium, lithium or similar are permitted.
- 5.17.7** Reciprocating and rotating components :
- a) Reciprocating and rotating components must not be manufactured from graphitic matrix, metal matrix composites or ceramic materials, this restriction does not apply to the clutch and any seals. Ceramic bearings are not permitted in ancillaries which are included when assessing the weight of the engine, e.g. alternator, coolant pumps and oil pumps.
  - b) Rolling elements of rolling element bearings must be manufactured from an iron based alloy.
  - c) Timing gears between the crankshaft and camshafts (including hubs) must be manufactured from an iron based alloy.
- 5.17.8** Static components :
- a) Engine crankcases and cylinder heads must be manufactured from cast or wrought aluminium alloys.  
No composite materials or metal matrix composites are permitted either for the whole component or locally.

- b) Any metallic structure whose primary or secondary function is to retain lubricant or coolant within the engine must be manufactured from an iron based alloy or an aluminium alloy of the Al-Si, Al-Cu, Al-Zn or Al-Mg alloying systems.
- c) All threaded fasteners must be manufactured from an alloy based on Cobalt, Iron or Nickel.  
Composite materials are not permitted.
- d) Valve seat inserts, valve guides and any other bearing component may be manufactured from metallic infiltrated pre-forms with other phases which are not used for reinforcement.

#### **5.18 Starting the engine :**

A supplementary device temporarily connected to the car may be used to start the engine both on the grid and in the pits.

#### **5.19 Stall prevention systems :**

If a car is equipped with a stall prevention system, and in order to avoid the possibility of a car involved in an accident being left with the engine running, all such systems must be configured to stop the engine no more than ten seconds after activation.

The sole purpose of such systems is to prevent the engine stalling when a driver loses control of the car. If the car is in second gear or above when the system is activated multiple gear changes may be made to either first gear or neutral, under all other circumstances the clutch alone may be activated.

Each time such a system is activated the clutch must be fully disengaged and must remain so until the driver de-activates the system by manually operating the clutch with a request greater than 95% of the total available travel of the drivers clutch actuation device.

#### **5.20 Replacing engine parts :**

The parts in lists A and B below may be changed without incurring a penalty under Article 28.4 of the F1 Sporting Regulations. If changing any of these parts involves breaking a seal this may be done but must be carried out under FIA supervision. The parts in List B may only be replaced by identical homologated parts in accordance with Appendix 4 of the F1 Sporting Regulations.

##### **List A**

- Clutch.
- Clutch basket.
- Hydraulic pumps.
- Engine electronic boxes (ECU's, power modules, control boxes).
- Fuel filters.
- Fuel pumps.
- Oil filters.
- Oil tank systems.
- Pneumatic bottles, regulators, pumps and pipes for valve actuation.
- Exhaust systems.
- Supports and brackets related to the auxiliaries, mentioned above.
- Screws, nuts, dowels or washers related to the auxiliaries, mentioned above.
- Cables, tubes or hoses related to the auxiliaries, mentioned above.
- Oil or air seals related to the auxiliaries, mentioned above.

- Spark plugs.

**List B**

- Throttle system (including but not limited to throttle device, linkage, actuator, hydraulics).
- Intake system external to cylinder head (including but not limited to trumpets, trumpet tray, air box, air filter).
- Ignition coils.
- Injection system.
- Alternators.
- Oil scavenging pumps.
- Oil supply pumps.
- Oil air separators.
- Water pumps.
- Electric and electronic sensors.

## **ARTICLE 6 : FUEL SYSTEM**

### **6.1 Fuel tanks :**

**6.1.1** The fuel tank must be a single rubber bladder conforming to or exceeding the specifications of FIA/FT5-1999, the fitting of foam within the tank however is not mandatory. A list of approved materials may be found in the Appendix to these regulations.

**6.1.2** All the fuel stored on board the car must be situated between the front face of the engine and the driver's back when viewed in lateral projection. When establishing the front face of the engine, no parts of the fuel, oil, water or electrical systems will be considered.

Furthermore, no fuel can be stored more than 300mm forward of the highest point at which the driver's back makes contact with his seat. However, a maximum of 2 litres of fuel may be kept outside the survival cell, but only that which is necessary for the normal running of the engine.

**6.1.3** Fuel must not be stored more than 400mm from the longitudinal axis of the car.

**6.1.4** All rubber bladders must be made by manufacturers recognised by the FIA. In order to obtain the agreement of the FIA, the manufacturer must prove the compliance of his product with the specifications approved by the FIA. These manufacturers must undertake to deliver to their customers exclusively tanks complying to the approved standards.

A list of approved manufacturers may be found in the Appendix to these regulations.

**6.1.5** All rubber bladders shall be printed with the name of the manufacturer, the specifications to which the tank has been manufactured and the date of manufacture.

**6.1.6** No rubber bladders shall be used more than 5 years after the date of manufacture.

### **6.2 Fittings and piping :**

**6.2.1** All apertures in the fuel tank must be closed by hatches or fittings which are secured to metallic or composite bolt rings bonded to the inside of the bladder. The total area of any such hatches or fittings which are in contact with the fuel may not exceed 30000mm<sup>2</sup>.

Bolt hole edges must be no less than 5mm from the edge of the bolt ring, hatch or fitting.

**6.2.2** All fuel lines between the fuel tank and the engine must have a self sealing breakaway valve. This valve must separate at less than 50% of the load required to break the fuel line fitting or to pull it out of the fuel tank.

**6.2.3** No lines containing fuel may pass through the cockpit.

**6.2.4** All lines must be fitted in such a way that any leakage cannot result in the accumulation of fuel in the cockpit.

### **6.3 Crushable structure :**

The fuel tank must be completely surrounded by a crushable structure, which is an integral part of the survival cell and must be able to withstand the loads required by the tests in Articles 18.2.1 and 18.3.

### **6.4 Fuel tank fillers :**

Fuel tank fillers must not protrude beyond the bodywork. Any breather pipe connecting the fuel tank to the atmosphere must be designed to avoid liquid leakage when the car is running and its outlet must not be less than 250mm from the cockpit opening.

All fuel tank fillers and breathers must be designed to ensure an efficient locking action which reduces the risk of an accidental opening following a crash impact or incomplete locking after refuelling.

## **6.5 Refuelling :**

- 6.5.1 A cover must be fitted over any refuelling connector at all times when the car is running on the track. The cover and its attachments must be sufficiently strong to avoid accidental opening in the event of an accident.
- 6.5.2 No fuel intended for immediate use in a car may be more than ten degrees centigrade below ambient temperature. When assessing compliance, the ambient temperature will be that recorded by the FIA appointed weather service provider one hour before any practice session or two hours before the race. This information will also be displayed on the timing monitors.  
  
The temperature of fuel intended for use in a car must be measured via an FIA approved and sealed sensor.
- 6.5.3 The use of any device on board the car to decrease the temperature of the fuel is forbidden.

## **6.6 Fuel draining and sampling :**

- 6.6.1 Competitors must provide a means of removing all fuel from the car.
- 6.6.2 Competitors must ensure that a one litre sample of fuel may be taken from the car at any time during the Event.  
  
Except in cases of force majeure (accepted as such by the stewards of the meeting), if a sample of fuel is required after a practice session the car concerned must have first been driven back to the pits under its own power.
- 6.6.3 All cars must be fitted with a –2 'Symetrics' male fitting in order to facilitate fuel sampling. If an electric pump on board the car cannot be used to remove the fuel an externally connected one may be used provided it is evident that a representative fuel sample is being taken. If an external pump is used it must be possible to connect the FIA sampling hose to it and any hose between the car and pump must be -3 in diameter and not exceed 2m in length. Details of the fuel sampling hose may be found in the Appendix to these regulations.
- 6.6.4 The sampling procedure must not necessitate starting the engine or the removal of bodywork (other than the cover over any refuelling connector).

## **ARTICLE 7 : OIL AND COOLANT SYSTEMS**

### **7.1 Location of oil tanks :**

All oil storage tanks must be situated between the front wheel axis and the rearmost gearbox casing longitudinally, and must be no further than the lateral extremities of the survival cell are from the longitudinal axis of the car.

### **7.2 Longitudinal location of oil system :**

No other part of the car containing oil may be situated behind the complete rear wheels.

### **7.3 Catch tank :**

In order to avoid the possibility of oil being deposited on the track, the engine sump breather must vent into the main engine air intake system.

### **7.4 Transversal location of oil system :**

No part of the car containing oil may be more than 700mm from the car centre line.

### **7.5 Coolant header tank :**

The coolant header tank on the car must be fitted with an FIA approved pressure relief valve which is set to a maximum of 3.75 bar gauge pressure, details of the relief valve may be found in the Appendix to these regulations. If the car is not fitted with a header tank, an alternative position must be approved by the FIA.

### **7.6 Cooling systems :**

The cooling systems of the engine must not intentionally make use of the latent heat of vaporisation of any fluid.

### **7.7 Oil and coolant lines :**

**7.7.1** No lines containing coolant or lubricating oil may pass through the cockpit.

**7.7.2** All lines must be fitted in such a way that any leakage cannot result in the accumulation of fluid in the cockpit.

**7.7.3** No hydraulic fluid lines may have removable connectors inside the cockpit.

## **ARTICLE 8 : ELECTRICAL SYSTEMS**

### **8.1 Software and electronics inspection :**

- 8.1.1** Prior to the start of each season the complete electrical system on the car must be examined and all on board and communications software must be inspected by the FIA Technical Department.

The FIA must be notified of any changes prior to the Event at which such changes are intended to be implemented.

- 8.1.2** All re-programmable microprocessors must have a mechanism that allows the FIA to accurately identify the software version loaded.

Acceptable solutions to verify the programmed software may be found in the Appendix to these regulations.

- 8.1.3** All electronic units containing a programmable device, and which are intended for use at an Event, must be presented to the FIA before each Event in order that they can be identified.

- 8.1.4** All on-car software versions must be registered with the FIA before use.

- 8.1.5** The FIA must be able to test the operation of any compulsory electronic safety systems at any time during an Event.

### **8.2 Control electronics :**

- 8.2.1** All components of the engine, gearbox, clutch, differential and KERS in addition to all associated actuators must be controlled by an Electronic Control Unit (ECU) which has been manufactured by an FIA designated supplier to a specification determined by the FIA.

The ECU may only be used with FIA approved software and may only be connected to the control system wiring loom, sensors and actuators in a manner specified by the FIA.

Additional information regarding the ECU software versions and setup may be found in the Appendix to these regulations.

- 8.2.2** All control sensors, actuators and FIA monitoring sensors will be specified and homologated by the FIA. Details of the homologation process may be found in the Appendix to these regulations.

Each and every component of the control system will be sealed and uniquely identified and their identities tracked through their life cycle.

These components and units may not be disassembled or modified in any way and seals and identifiers must remain intact and legible.

- 8.2.3** The control system wiring loom connectivity must be approved by the FIA.

All wiring looms must be built to ensure that each control sensor and each control actuator connected to the ECU is electrically isolated from logging-only sensors connected to either the ECU or a team data acquisition unit.

In general, there must be no active or passive electronic component in the control loom. Exceptions (e.g. termination resistors) must be approved by the FIA before use.

Additional wiring guidelines may be found in the Appendix to these regulations.

- 8.2.4** If sensor faults or errors are detected by the driver or by the on-board software, back-up sensors may be used and different settings may be manually or automatically selected. However, any back-up sensor or new setting chosen in this way must not enhance the performance of the car. Any driver default turned on during the start lockout period may not be turned off before the end of that period.



- 8.2.5 Pneumatic valve pressure may only be controlled via a passive mechanical regulator or from the ECU and its operation will be monitored by the ECU.
- 8.2.6 The ECU will be designed to run from a car system supply voltage of 12V nominal provided by a homologated voltage regulator.

### 8.3 Start systems :

Any system, the purpose and/or effect of which is to detect when a race start signal is given, is not permitted.

The ECU will implement a “lockout” period after each race start or pit stop during which a number of engine and clutch related functions will be frozen or disabled. Details of the strategy may be found in the Appendix to these regulations.

### 8.4 Data acquisition :

- 8.4.1 To assist scrutineering, the FIA requires unlimited access to the following ECU information before, during and after any track session :

- Application parameter configurations.
- Logged data and events.
- Real-time telemetry data and events.

Throughout the Event, the logging memory and events buffer may only be cleared by an FIA engineer.

The FIA must have the ability to connect to the ECU via a jump battery using an FIA laptop. The teams should make a jump battery available at all times during the Event.

The teams should transfer the real-time telemetry data and events on the FIA network as requested by, and in the format defined by, the FIA.

Prior to the race, the ECU data logger must be configured in such a way that allows logging of data for at least two hours and fifteen minutes without exceeding the size of the logger memory.

- 8.4.2 Any data acquisition system, telemetry system or associated sensors additional to those provided by the ECU and ADR must be physically separate and electrically isolated from any control electronics with the exception of :

- The primary regulated voltage supply.
- The car system ground.
- Communication links to the ECU, telemetry unit and ADR.
- Power supplies, provided they are not used to power any control electronics, control sensors or actuators.
- Time synchronisation lines.
- Engine synchronisation lines.
- An umbilical loom whose connector will remain disconnected when the car is moving.

No junction box or break-out box may be shared between the ECU system and a team data acquisition system.

### 8.5 Telemetry :

- 8.5.1 Telemetry systems must operate at frequencies which have been approved by the FIA.
- 8.5.2 Pit to car telemetry is prohibited.

## **8.6 Driver controls and displays :**

Any electronic modules used for driver information displays and switch inputs must be supplied by an FIA designated supplier to a specification determined by the FIA and be suitably housed by each team.

Any single switch, button, paddle sensor or pedal sensor used by the driver must be connected to a single analogue or digital input of the ECU. Exceptions will be considered to handle the spare clutch paddle and multiplexed shift signals. Any interface between such driver operated devices and the ECU must be approved by the FIA.

The logged raw signals from the ECU inputs must provide a true representation of the driver's actions.

## **8.7 Driver radio :**

Other than authorised connections to the FIA ECU, any voice radio communication system between car and pits must be stand-alone and must not transmit or receive other data. All such communications must be open and accessible to both the FIA and broadcasters.

## **8.8 Accident data recorders (ADR) :**

### **8.8.1** The recorder must be fitted and operated :

- In accordance with the instructions of the FIA.
- Symmetrically about the car centre line and with its top facing upwards.
- With each of its 12 edges parallel to an axis of the car.
- Less than 50mm above the reference plane.
- In a position within the cockpit which is readily accessible at all times from within the cockpit without the need to remove skid block or floor.
- In order that the entire unit lies between 30% and 50% of the wheelbase of the car.
- Via anti-vibration mountings giving a clearance of 5mm to all other objects.
- With its connectors facing forwards.
- In order that its status light is visible when the driver is seated normally.
- In order that the download connector is easily accessible when the driver is seated normally and without the need to remove bodywork.

**8.8.2** The recorder must be connected to two external 500g accelerometers which are solidly bolted to the survival cell, on the car centre line, using four 4mm bolts. One must be as close to the nominal car centre of gravity as practical and the other as far forward as possible inside the survival cell. The forward accelerometer may be mounted to the underside of the top surface provided it is solidly bolted to a structural part of the survival cell.

**8.8.3** The recorder must be powered from a nominally 12V supply such that its internal battery can be recharged at all times when the car's electronic systems are powered and when the car systems are switched off, but a jump battery or umbilical is connected.

**8.8.4** An ADR and two accelerometers must be fitted to every car at all times during an Event and at all tests attended by more than one team.

**8.8.5** Details of the connections to the ADR may be found in the Appendix to these regulations.

## **8.9 Track signal information display :**

All cars must be fitted with red, blue and yellow cockpit lights the purpose of which are to give drivers information concerning track signals or conditions. The lights must be LEDs each with a minimum diameter of 5mm and fitted directly in the driver's normal line of sight.

Details of the light control system, which must be fitted to every car, may be found in the Appendix to these regulations.

#### **8.10 Medical warning system :**

In order to give rescue crews an immediate indication of accident severity each car must be fitted with a warning light which is connected to the FIA data logger.

The light must face upwards and be recessed into the top of the survival cell no more than 150mm from the car centre line and the front of the cockpit opening and as near to the clutch disengagement system, as described in Article 9.4, as is practical.

Details of the light and its control system may be found in the Appendix to these regulations.

#### **8.11 Installation of electrical systems or components :**

**8.11.1** Exceptionally, each car may be equipped with a maximum of five test sensor installations, which do not comply with the Technical Regulations, during P1 and P2, provided :

- They could not materially affect the outcome any of the impact tests described in articles 16.2, 16.3, 16.4 and 16.5.
- They comply with Articles 3.3, 3.4.1, 3.6, 3.14.1 and 3.14.2.
- They do not reduce or affect driver visibility.
- They do not obstruct on-board camera views.

Any such test sensor installations do not need to be homologated.

The FIA technical delegate must be notified of any intended test sensor installations prior to the Event at which they are first used.

**8.11.2** Competitors must be notified of any changes to the installation instructions for any FIA specified systems or components before 30 June of the previous season.

## ARTICLE 9 : TRANSMISSION SYSTEM

### 9.1 Transmission types :

No transmission system may permit more than two wheels to be driven.

### 9.2 Clutch control :

The following applies only to the main drivetrain clutch or clutches, any clutch used exclusively as part of a KERS is exempt.

- 9.2.1 If multiple clutch operating devices are used, they must all have the same mechanical travel characteristics and be mapped identically.
- 9.2.2 Designs which allow specific points along the travel range of the clutch operating device to be identified by the driver or assist him to hold a position are not permitted.
- 9.2.3 The minimum and maximum travel positions of the clutch operating device must correspond to the clutch fully engaged normal rest position and fully disengaged (incapable of transmitting any useable torque) positions respectively.
- 9.2.4 Designs or systems which in addition to typical inherent hydraulic and mechanical properties are designed to, or have the effect of, adjusting or otherwise influencing the amount, or rate, of engagement being demanded by the FIA ECU, are not permitted.
- 9.2.5 The amount by which the clutch is engaged must be controlled solely and directly by the driver with the exception of :

- Stall prevention.
- Gearshifts.
- Bite point finder where brake pressure, wheel speed and driver clutch demand safeguards are used.
- De-clutch protections.
- Drivetrain protection on the track outside of any start lockout period or immediately following stall prevention activation only.
- Test signals enabled only when the car is connected to the garage system.

The relationship between the clutch operating device in the cockpit and the amount of clutch engagement may be non-linear but must remain fixed.

- 9.2.6 When the clutch operating device is released from its maximum travel position it must return to its resting position within 50ms.

The maximum delay allowed, computed from the respective positions as recorded by the ADR or ECU, between the clutch driver control input signal and the corresponding output demand being achieved is 50ms.

- 9.2.7 Any device or system which notifies the driver of the amount of clutch slip or engagement is not permitted.

### 9.3 Traction control :

No car may be equipped with a system or device which is capable of preventing the driven wheels from spinning under power or of compensating for excessive throttle torque demand by the driver.

Any device or system which notifies the driver of the onset of wheel spin is not permitted.

#### **9.4 Clutch disengagement :**

All cars must be fitted with a means of disengaging the clutch for a minimum of fifteen minutes in the event of the car coming to rest with the engine stopped. This system must be in working order throughout the Event even if the main hydraulic, pneumatic or electrical systems on the car have failed. This system must also disconnect any KERS system fitted to the car.

In order that the driver or a marshal may activate the system in less than five seconds, the switch or button which operates it must :

- face upwards and be recessed into the top of the survival cell no more than 150mm from the car centre line ;
- be designed in order that a marshal is unable to accidentally re-engage the clutch ;
- be less than 150mm from the front of the cockpit opening ;
- Be marked with a letter "N" in red at least 40mm tall, with a line thickness of at least 4mm, inside a white circle of at least 50mm diameter with a red edge with a line thickness of at least 2mm.

#### **9.5 Gearboxes :**

**9.5.1** A gearbox is defined as all the parts in the drive line which transfer torque from the engine crankshaft to the drive shafts (the drive shafts being defined as those components which transfer drive torque from the sprung mass to the un-sprung mass). It includes all components whose primary purpose is for the transmission of power or mechanical selection of gears, bearings associated with these components and the casing in which they are housed.

**9.5.2** In this context the following parts are not considered part of the gearbox and may be changed without incurring a penalty under the F1 Sporting Regulations. If changing any of these parts involves breaking an FIA applied seal this may be done but must be carried out under FIA supervision :

- The clutch assembly and any shaft connecting the clutch to the crankshaft or first motion shaft of the gearbox, provided this is located prior to any mechanical speed reduction from the engine.
- The clutch actuator and clutch release bearing(s).
- Inboard driveshaft joints and seals but not their housing if that housing is integral with the gearbox output shaft and therefore part of the sprung mass.
- The hydraulic system prior to the point at which it produces direct mechanical movement of the gear selection mechanism by means of hydraulic actuator(s).
- Oil, oil pumps, oil filters, oil seals, oil coolers and any associated hoses or pipes.
- Electrical sensors, actuators, servo valves and wiring.
- Any parts associated with the suspension or functioning of the sprung suspension that are attached to the gearbox casing.
- The rear impact structure provided it can be separated from any gearbox casing.
- Any other component mounted to the casing whose primary purpose is unconnected with the transmission of power or selection of gears.

#### **9.6 Gear ratios :**

**9.6.1** The maximum number of forward gear ratios is 7.

**9.6.2** The maximum number of numerical change gear ratio pairs a competitor has available to him during a Championship season is 30. All such gear ratio pairs must be declared to the FIA technical delegate at or before the first Event of the Championship.

**9.6.3** No forward gear ratio pair may be :

- Less than 12mm wide when measured across the gear tooth at the root diameter or any point 1mm above or below the root diameter. Above this area each side of the gear teeth may be chamfered by a maximum of 10°. In addition, a chamfer or radius not exceeding 2.0mm may be applied to the sides and the tip of the teeth.
- Less than 85mm between centres.
- Less than 600g in weight (excluding any integral shaft or collar). If an integral shaft or collar is to be excluded the mass of this may be shown by calculation assuming the gear to be 12mm wide and the shaft geometry to be the same as that where slide on gears are used.

**9.6.4** Gear ratios must be made from steel.

**9.6.5** Continuously variable transmission systems are not permitted to transmit the power of the engine defined in Article 5.1.

### **9.7 Reverse gear :**

All cars must have a reverse gear operable any time during the Event by the driver when the engine is running.

### **9.8 Gear changing :**

**9.8.1** Automatic gear changes are considered a driver aid and are therefore not permitted.

For the purposes of gear changing, the clutch and throttle need not be under the control of the driver.

**9.8.2** Gear changing is restricted during the following periods :

- Race start: one gear change is permitted after the race has started and before the car speed has reached 100kph, provided every gear fitted to the car is capable of achieving at least 100km/h at 18,000rpm.
- Pit stops: No gear change is permitted after a pit stop and until the car speed gets within 10km/h of the pit lane speed limit when leaving the pits.

**9.8.3** The minimum possible gear the driver is able to select must remain fixed whilst the car is moving.

Each individual gear change must be separately initiated by the driver and, within the mechanical constraints of the gearbox; the requested gear must be engaged immediately unless over-rev protection is used to reject the gear shift request. Once a gear change request has been accepted no further requests may be accepted until the first gear change has been completed.

Multiple gear changes may only be made under Article 5.19 or when a shift to gearbox neutral is made following a request from the driver.

If an over-rev protection strategy is used this may only prevent engagement of the target gear, it must not induce a delay greater than 50ms. If a gear change is refused in this way, engagement may only follow a new and separate request made by the driver.

Any de-bounce time used to condition driver gear change requests must be fixed.

**9.8.4** The maximum permitted duration for down changes and up changes is 300ms and 200ms respectively. The maximum permitted delay for the latter is 80ms from the time of the driver request to the original gear being disengaged.

The duration of a gear change is defined as the time from the request being made to the point at which all gear change processes are terminated. If for any reason the gear change cannot be completed in that time the car must be left in neutral or the original gear.

**9.8.5** Distance channel or track position is not considered an acceptable input to gearbox control.

### **9.9 Torque transfer systems :**

**9.9.1** Any system or device the design of which is capable of transferring or diverting torque from a slower to a faster rotating wheel is not permitted.

**9.9.2** Any device which is capable of transferring torque between the principal axes of rotation of the two front wheels is prohibited.

### **9.10 Kinetic Energy Recovery System :**

**9.10.1** The KERS must connect at any point in the rear wheel drivetrain before the differential.

**9.10.2** The system will be considered shut down when all energy is contained within the KERS modules and no high voltage is present on any external or accessible part of any KERS module.

The shutdown process must take no longer than two seconds from activation.

**9.10.3** It must be possible to shut down the KERS via the following means :

- The switch required by Article 14.2.1.
- The switches required by Article 14.2.2.
- The switch or button required by Article 9.4.

**9.10.4** The KERS must shut down when the ECU required by Article 8.2 initiates an anti-stall engine shut off.

**9.10.5** All cars fitted with a KERS must be fitted with a KERS status light which :

- Is in working order throughout the Event even if the main hydraulic, pneumatic or electrical systems on the car have failed.
- Is located in the same general location as the light required by Article 8.10.
- Is green only when the system is shut down and no electrical insulation fault has been detected.
- Remains powered for at least 15 minutes if the car comes to rest with its engine stopped.
- Is marked with a "HIGH VOLTAGE" symbol according to ISO3864 of at least 30mm along the triangle side.

## **ARTICLE 10 : SUSPENSION AND STEERING SYSTEMS**

### **10.1 Sprung suspension :**

10.1.1 Cars must be fitted with sprung suspension.

10.1.2 The suspension system must be so arranged that its response results only from changes in load applied to the wheels.

### **10.2 Suspension geometry :**

10.2.1 With the steering wheel fixed, the position of each wheel centre and the orientation of its rotation axis must be completely and uniquely defined by a function of its principally vertical suspension travel, save only for the effects of reasonable compliance which does not intentionally provide further degrees of freedom.

10.2.2 Any powered device which is capable of altering the configuration or affecting the performance of any part of the suspension system is forbidden.

10.2.3 No adjustment may be made to the suspension system while the car is in motion.

### **10.3 Suspension members :**

10.3.1 With the exception of minimal local changes of section for the passage of hydraulic brake lines, electrical wiring and wheel tethers or the attachment of flexures, rod ends and spherical bearings, the cross-sections of each member of every suspension component, when taken normal to a straight line between the inner and outer attachment points, must :

- Intersect the straight line between the inner and outer attachment points.
- Have a major axis no greater than 100mm.
- Have an aspect ratio no greater than 3.5:1.
- Be nominally symmetrical about its major axis.

The major axis will be defined as the largest dimension of any such cross-section.

10.3.2 Suspension members having shared attachment points will be considered by a virtual dissection into discrete members.

10.3.3 No major axis of a cross section of a suspension member, when assessed in accordance with Article 10.3.1, may subtend an angle greater than 5° to the reference plane when projected onto, and normal to, a vertical plane on the car centre line with the car set to the nominal design ride height.

10.3.4 Non-structural parts of suspension members are considered bodywork.

10.3.5 There may be no more than six suspension members connecting each suspension upright to the fully sprung part of the car.

Redundant suspension members are not permitted.

10.3.6 In order to help prevent a wheel becoming separated in the event of all suspension members connecting it to the car failing provision must be made to accommodate flexible tethers, each with a cross sectional area greater than 110mm<sup>2</sup>. The sole purpose of the tethers is to prevent a wheel becoming separated from the car, they should perform no other function.

The tethers and their attachments must also be designed in order to help prevent a wheel making contact with the driver's head during an accident.

Each wheel must be fitted with two tethers each of which exceed the requirements of 3.1.1 of Test Procedure 03/07.



Each tether must have its own separate attachments at both ends which :

- Are able to withstand a tensile force of 70kN in any direction within a cone of 45° (included angle) measured from the load line of the relevant suspension member.
- On the survival cell or gearbox are separated by at least 100mm measured between the centres of the two attachment points.
- On each wheel/upright assembly are separated by at least 90° radially with respect to the axis of the wheel and 100mm measured between the centres of the two attachment points.
- Are able to accommodate tether end fittings with a minimum inside diameter of 15mm.

Furthermore, no suspension member may contain more than one tether.

Each tether must exceed 450mm in length and must utilise end fittings which result in a tether bend radius greater than 7.5mm.

#### **10.4 Steering :**

- 10.4.1** Any steering system which permits the re-alignment of more than two wheels is not permitted.
- 10.4.2** Power assisted steering systems may not be electronically controlled or electrically powered. No such system may carry out any function other than reduce the physical effort required to steer the car.
- 10.4.3** No part of the steering wheel or column, nor any part fitted to them, may be closer to the driver than a plane formed by the entire rear edge of the steering wheel rim. All parts fixed to the steering wheel must be fitted in such a way as to minimise the risk of injury in the event of a driver's head making contact with any part of the wheel assembly.
- 10.4.4** The steering wheel, steering column and steering rack assembly must pass an impact test, details of the test procedure may be found in Article 16.6.

#### **10.5 Suspension Uprights :**

- 10.5.1** The suspension uprights must be made from a permitted aluminium alloy. Particulate reinforced aluminium alloy matrix composites are forbidden.
- 10.5.2** The loads from the suspension members and wheel bearings must individually and entirely be carried by the suspension upright. Exceptionally up to three suspension members may be connected together by titanium, aluminium alloy or steel components before their load is passed into the upright.
- 10.5.3** Suspension uprights may not protrude beyond :
  - A vertical plane parallel to the inner face of the wheel rim and displaced from it by 120mm toward the car centre line.
  - A radius of 180mm from the centre of the wheel when viewed from the side.

The above measurements will be made with the wheel held in a vertical position.

## **ARTICLE 11 : BRAKE SYSTEM**

### **11.1 Brake circuits and pressure distribution :**

- 11.1.1 With the exception of a KERS, all cars must be equipped with only one brake system. This system must comprise solely of two separate hydraulic circuits operated by one pedal, one circuit operating on the two front wheels and the other on the two rear wheels. This system must be designed so that if a failure occurs in one circuit the pedal will still operate the brakes in the other.
- 11.1.2 The brake system must be designed in order that the force exerted on the brake pads within each circuit are the same at all times.
- 11.1.3 Any powered device which is capable of altering the configuration or affecting the performance of any part of the brake system is forbidden.
- 11.1.4 Any change to, or modulation of, the brake system whilst the car is moving must be made by the driver's direct physical input, may not be pre-set and must be under his complete control at all times.

### **11.2 Brake calipers :**

- 11.2.1 All brake calipers must be made from aluminium materials with a modulus of elasticity no greater than 80Gpa.
- 11.2.2 No more than two attachments may be used to secure each brake caliper to the car.
- 11.2.3 No more than one caliper, with a maximum of six pistons, is permitted on each wheel.
- 11.2.4 The section of each caliper piston must be circular.

### **11.3 Brake discs and pads :**

- 11.3.1 No more than one brake disc is permitted on each wheel.
- 11.3.2 All discs must have a maximum thickness of 28mm and a maximum outside diameter of 278mm.
- 11.3.3 No more than two brake pads are permitted on each wheel.

### **11.4 Air ducts :**

Air ducts around the front and rear brakes will be considered part of the braking system and shall not protrude beyond :

- A plane parallel to the ground situated at a distance of 160mm above the horizontal centre line of the wheel.
- A plane parallel to the ground situated at a distance of 160mm below the horizontal centre line of the wheel.
- A vertical plane parallel to the inner face of the wheel rim and displaced from it by 120mm toward the car centre line.

Furthermore :

- When viewed from the side the ducts must not protrude forwards beyond a radius of 330mm from the centre of the wheel or backwards beyond a radius of 180mm from the centre of the wheel.
- The ducts may not rotate with the wheels nor may they, or any of their mountings, protrude axially beyond the outer face of the wheel fastener.
- No part of the car, other than those specifically defined in Articles 12.8.1 and 12.8.2, may obscure any part of the wheel when viewed from the outside of the car towards the car centre line along the axis of the wheel.

All measurements will be made with the wheel held in a vertical position.

**11.5 Brake pressure modulation :**

**11.5.1** No braking system may be designed to prevent wheels from locking when the driver applies pressure to the brake pedal.

**11.5.2** No braking system may be designed to increase the pressure in the brake calipers above that achievable by the driver applying pressure to the pedal under static conditions.

**11.6 Liquid cooling :**

Liquid cooling of the brakes is forbidden.

## **ARTICLE 12 : WHEELS AND TYRES**

### **12.1 Location :**

Wheels must be external to the bodywork in plan view, with the rear aerodynamic device removed.

### **12.2 Number of wheels :**

The number of wheels is fixed at four.

### **12.3 Wheel material :**

Wheels must be made from AZ70 or AZ80 magnesium alloys.

### **12.4 Wheel dimensions :**

**12.4.1** Complete wheel width must lie between 305mm and 355mm when fitted to the front of the car and between 365mm and 380mm when fitted to the rear.

**12.4.2** Complete wheel diameter must not exceed 660mm when fitted with dry-weather tyres or 670mm when fitted with wet weather tyres.

**12.4.3** Complete wheel width and diameter will be measured horizontally at axle height, with the wheel held in a vertical position and when fitted with new tyres inflated to 1.4 bar.

**12.4.4** Wheel dimensions and geometry must comply with the following specifications :

- The minimum wheel thickness is 3.0mm.
- The minimum bead thickness is 4.0mm (measured from hump to outer edge of the lip).
- The ETRTO standard bead profile is prescribed.
- The tyre mounting widths are 12" (304.8mm +/-0.5mm) front; 13.7" (348.0mm +/-0.5mm) rear.
- The wheel lip thickness is 9mm (+/-1mm).
- The outer lip diameter is 358mm (+/-1mm).
- A lip recess of maximum 1.0mm depth between a radius of 165mm and a radius of 173mm from wheel axis is permitted (for wheel branding, logo, part number, etc).
- With the exception of the wheel lip, only a single turned profile with a maximum thickness of 8mm is allowed radially outboard of the exclusion zones specified in Article 12.4.5.
- The design of the wheel must meet the general requirements of the tyre supplier for the mounting and dismounting of tyres including allowance for sensors and valves.
- The wheel design cannot be handed between left and right designs.

**12.4.5** No wheel material is permitted in the following exclusion zones :

- A concentric cylinder of diameter 305mm and length 115mm positioned with its inner face lying in the same plane as the inboard face of the front wheel.
- A concentric cylinder of diameter 305mm and length 25mm positioned with its outer face lying in the same plane as the outboard face of the front wheel.
- A concentric cylinder of diameter 305mm and length 100mm positioned with its inner face lying in the same plane as the inboard face of the rear wheel.
- A concentric cylinder of diameter 305mm and length 30mm positioned with its outer face lying in the same plane as the outboard face of the rear wheel.

12.4.6 When viewed perpendicular to the plane formed by the outer face of the wheel and between the diameters of 120mm and 270mm the wheel may have an area of no greater than 24,000mm<sup>2</sup>.

## 12.5 Supply of tyres :

12.5.1 All tyres must be used as supplied by the manufacturer, any modification or treatment such as cutting, grooving, the application of solvents or softeners is prohibited. This applies to dry, intermediate and wet-weather tyres.

12.5.2 If, in the opinion of the appointed tyre supplier and FIA technical delegate, the nominated tyre specification proves to be technically unsuitable, the stewards may authorise the use of additional tyres to a different specification.

12.5.3 If, in the interests of maintaining current levels of circuit safety, the FIA deems it necessary to reduce tyre grip, it shall introduce such rules as the tyre supplier may advise or, in the absence of advice which achieves the FIA's objectives, specify the maximum permissible contact areas for front and rear tyres.

## 12.6 Specification of tyres :

12.6.1 An intermediate tyre is one which has been designed for use on a wet or damp track.

All intermediate tyres must, when new, have a contact area which does not exceed 280cm<sup>2</sup> when fitted to the front of the car and 440cm<sup>2</sup> when fitted to the rear. Contact areas will be measured over any square section of the tyre which is normal to and symmetrical about the tyre centre line and which measures 200mm x 200mm when fitted to the front of the car and 250mm x 250mm when fitted to the rear. For the purposes of establishing conformity, void areas which are less than 2.5mm in depth will be deemed to be contact areas.

12.6.2 A wet-weather tyre is one which has been designed for use on a wet track.

All wet-weather tyres must, when new, have a contact area which does not exceed 240cm<sup>2</sup> when fitted to the front of the car and 375cm<sup>2</sup> when fitted to the rear. Contact areas will be measured over any square section of the tyre which is normal to and symmetrical about the tyre centre line and which measures 200mm x 200mm when fitted to the front of the car and 250mm x 250mm when fitted to the rear. For the purposes of establishing conformity, void areas which are less than 5.0mm in depth will be deemed to be contact areas.

12.6.3 Tyre specifications will be determined by the FIA no later than 1 September of the previous season. Once determined in this way, the specification of the tyres will not be changed during the Championship season without the agreement of all competing teams.

## 12.7 Treatment of tyres :

12.7.1 Tyres may only be inflated with air or nitrogen.

12.7.2 Any process the intent of which is to reduce the amount of moisture in the tyre and/or in its inflation gas is forbidden.

12.7.3 The only permitted type of tyre heating devices are blankets which use resistive heating elements. The heating elements may only act upon the outer tyre surface.

## 12.8 Wheel assembly :

12.8.1 The only parts which may be physically attached to the wheel in addition to the tyre are surface treatments for appearance and protection, valves for filling and discharging the tyre, wheel fasteners, balance weights, drive pegs, tyre pressure and temperature monitoring devices and spacers on the inboard mounting face of identical specification on all wheels for the same axle.

- 12.8.2** The wheel must be attached to the car with a single fastener. The outer diameter of the fastener must not exceed 105mm and the axial length must not exceed 75mm. The wheel fastener may not attach or mount any part to the car except the wheel assembly described in Article 12.8.1.
- 12.8.3** A complete wheel must contain a single fixed internal gas volume. No valves, bleeds or permeable membranes are permitted other than to inflate or deflate the tyre whilst the car is stationary.
- 12.8.4** Devices which are used to fit or remove wheel fasteners may only be powered by compressed air or nitrogen.
- Any sensor systems may only act passively.

## **ARTICLE 13 : COCKPIT**

### **13.1 Cockpit opening :**

**13.1.1** In order to ensure that the opening giving access to the cockpit is of adequate size, the template shown in drawing 2 will be inserted into the survival cell and bodywork.

During this test the steering wheel, steering column, seat and all padding required by Articles 14.6.1-6 (including fixings), may be removed and :

- The template must be held horizontal and lowered vertically from above the car until its lower edge is 525mm above the reference plane.
- Referring to drawing 2, the edge of the template which lies on the line d-e must be no less than 1800mm behind the line A-A shown in drawing 5.

Any measurements made from the cockpit entry template (when referred to in Articles 13.1.3, 14.3.3, 15.2.2, 15.4.5, 15.4.6, 15.5.4, 16.3 and 18.5), must also be made whilst the template is held in this position.

**13.1.2** The forward extremity of the cockpit opening, even if structural and part of the survival cell, must be at least 50mm in front of the steering wheel.

**13.1.3** The driver must be able to enter and get out of the cockpit without it being necessary to open a door or remove any part of the car other than the steering wheel. When seated normally, the driver must be facing forwards and the rearmost part of his crash helmet may be no more than 125mm forward of the rear edge of the cockpit entry template.

**13.1.4** From his normal seating position, with all seat belts fastened and whilst wearing his usual driving equipment, the driver must be able to remove the steering wheel and get out of the car within 5 seconds and then replace the steering wheel in a total of 10 seconds.

For this test, the position of the steered wheels will be determined by the FIA technical delegate and after the steering wheel has been replaced steering control must be maintained.

### **13.2 Steering wheel :**

The steering wheel must be fitted with a quick release mechanism operated by pulling a concentric flange installed on the steering column behind the wheel.

### **13.3 Internal cross section :**

**13.3.1** A free vertical cross section, which allows the outer template shown in drawing 3 to be passed vertically through the cockpit to a point 100mm behind the face of the rearmost pedal when in the inoperative position, must be maintained over its entire length.

The only things which may encroach on this area are the steering wheel and any padding that is required by Article 14.6.7.

**13.3.2** A free vertical cross section, which allows the inner template shown in drawing 3 to be passed vertically through the cockpit to a point 100mm behind the face of rearmost pedal when in the inoperative position, must be maintained over its entire length.

The only thing which may encroach on this area is the steering wheel.

**13.3.3** The driver, seated normally with his seat belts fastened and with the steering wheel removed must be able to raise both legs together so that his knees are past the plane of the steering wheel in the rearward direction. This action must not be prevented by any part of the car.

### **13.4 Position of the driver's feet :**

**13.4.1** The survival cell must extend from behind the fuel tank in a forward direction to a point at least 300mm in front of the driver's feet, with his feet resting on the pedals and the pedals in the inoperative position.

**13.4.2** When he is seated normally, the soles of the driver's feet, resting on the pedals in the inoperative position, must not be situated forward of the front wheel centre line.



## **ARTICLE 14 : SAFETY EQUIPMENT**

### **14.1 Fire extinguishers :**

- 14.1.1** All cars must be fitted with a fire extinguishing system which will discharge into the cockpit and into the engine compartment.
- 14.1.2** Any extinguishant listed in the Appendix to the regulations is permitted.
- 14.1.3** The quantity of extinguishant may vary according to the type of extinguishant used, a list of quantities may be found in the Appendix to these regulations.
- 14.1.4** When operated, the fire extinguishing system must discharge 95% of its contents at a constant pressure in no less than 10 seconds and no more than 30 seconds.
- If more than one container with extinguishant is fitted, they must be released simultaneously.
- 14.1.5** Each pressure vessel must be equipped with a means of checking its pressure which may vary according to the type of extinguishant used. A list of pressures may be found in the Appendix to the regulations.
- 14.1.6** The following information must be visible on each container with extinguishant :
- a) Type of extinguishant.
  - b) Weight or volume of the extinguishant.
  - c) Date the container must be checked which must be no more than two years after the date of filling.
- 14.1.7** All parts of the extinguishing system must be situated within the survival cell and all extinguishing equipment must withstand fire.
- 14.1.8** Any triggering system having its own source of energy is permitted, provided it is possible to operate all extinguishers should the main electrical circuits of the car fail.
- The driver must be able to trigger the extinguishing system manually when seated normally with his safety belts fastened and the steering wheel in place.
- Furthermore, a means of triggering from the outside must be combined with the circuit breaker switches described in Article 14.2.2. They must be marked with a letter "E" in red at least 80mm tall, with a line thickness of at least 8mm, inside a white circle of at least 100mm diameter with a red edge with a line thickness of at least 4mm.
- 14.1.9** The system must work in any position, even when the car is inverted.
- 14.1.10** All extinguisher nozzles must be suitable for the extinguishant and be installed in such a way that they are not directly pointed at the driver.

### **14.2 Master switch :**

- 14.2.1** The driver, when seated normally with the safety belts fastened and the steering wheel in place, must be able to cut off the electrical circuits to the ignition, all fuel pumps and the rear light by means of a spark proof circuit breaker switch.
- This switch must be located on the dashboard and must be clearly marked by a symbol showing a red spark in a white edged blue triangle.
- 14.2.2** There must also be two exterior horizontal handles which are capable of being operated from a distance by a hook. These handles must be situated at the base of the main roll over structure on both sides of the car and have the same function as the switch described in Article 14.2.1.

### **14.3 Rear view mirrors :**

- 14.3.1** All cars must have two mirrors mounted so that the driver has visibility to the rear and both sides of the car.
- 14.3.2** The reflective surface of each mirror must be at least 150mm wide, this being maintained over a height of at least 50mm. Additionally, each corner may have a radius no greater than 10mm.
- 14.3.3** All parts of the rear view mirrors, including their housings and mountings, must be situated between 250mm and 500mm from the car centre line and between 550mm and 750mm from the rear edge of the cockpit entry template.
- 14.3.4** The FIA technical delegate must be satisfied by a practical demonstration that the driver, when seated normally, can clearly define following vehicles.

For this purpose, the driver shall be required to identify any letter or number, 150mm high and 100mm wide, placed anywhere on boards behind the car, the positions of which are detailed below :

- Height : From 400mm to 1000mm from the ground.
- Width : 4000mm either side of the car centre line.
- Position : 10m behind the rear wheel centre line.

### **14.4 Safety belts :**

It is mandatory to wear two shoulder straps, one abdominal strap and two straps between the legs. These straps must be securely fixed to the car and must comply with FIA standard 8853/98.

### **14.5 Rear light :**

All cars must have a red light in working order throughout the Event which :

- Has been supplied by an FIA designated manufacturer.
- Faces rearwards at 90° to the car centre line and the reference plane.
- Is clearly visible from the rear.
- Is mounted nominally on the car centre line.
- Is mounted 300mm (+/-5mm) above the reference plane.
- Is no less than 595mm behind the rear wheel centre line measured parallel to the reference plane.
- Can be switched on by the driver when seated normally in the car.

The two measurements above will be taken to the centre of the rear face of the light unit.

### **14.6 Cockpit padding :**

- 14.6.1** All cars must be equipped with three areas of padding for the driver's head which :
- Are so arranged that they can be removed from the car as one part.
  - Are located by two horizontal pegs behind the driver's head and two fixings, which are clearly indicated and easily removable without tools, at the front corners.
  - Are made from a material which is suitable for the relevant ambient air temperature, details of approved materials and the temperature bands in which they should be used may be found in the Appendix to these regulations.

- Are covered, in all areas where the driver's head is likely to make contact, with two plies of Aramid fibre/epoxy resin composite pre-preg material in plain weave 60gsm fabric with a cured resin content of 50% (+/-5%) by weight.
- Are positioned so as to be the first point of contact for the driver's helmet in the event of an impact projecting his head towards them during an accident.

**14.6.2** The first area of padding for the driver's head must be positioned behind him and be between 75mm and 90mm thick over an area of at least 40000mm<sup>2</sup>. If necessary, and only for driver comfort, an additional piece of padding no greater than 10mm thick may be attached to this headrest provided it is made from a similar material which incorporates a low friction surface.

**14.6.3** Whilst he is seated normally the two further areas of padding for the driver's head must be positioned in an area bounded by two vertical lines and one horizontal line through the front, rear and lower extremities of the driver's helmet (on the car centre line), and the upper surface of the survival cell.

Each of these must cover an area greater than 33000mm<sup>2</sup> when viewed from the side of the car and be no less than 95mm thick, this minimum thickness being maintained to the upper edges of the survival cell and over their entire length. The minimum thickness will be assessed perpendicular to the car centre line but a radius no greater than 10mm may be applied along their upper inboard edges.

If necessary, and only for driver comfort, an additional piece of padding no greater than 10mm thick may be attached to these headrests provided they are made from a similar material which incorporates a low friction surface.

**14.6.4** Forward of the side areas of padding further cockpit padding must be provided on each side of the cockpit rim. The purpose of the additional padding is to afford protection to the driver's head in the event of an oblique frontal impact and must therefore be made from the same material as the other three areas of padding.

These extensions must :

- Be symmetrically positioned about the car centre line and a continuation of the side areas of padding.
- Be positioned with their upper surfaces at least as high as the survival cell over their entire length.
- Have a radius on their upper inboard edge no greater than 10mm.
- Be positioned in order that the distance between the two is no less than 320mm.
- Be as high as practicable within the constraints of driver comfort.

**14.6.5** All of the padding described above must be so installed that if movement of the driver's head, in any expected trajectory during an accident, were to compress the foam fully at any point, his helmet would not make contact with any structural part of the car.

Furthermore, for the benefit of rescue crews all of the padding described above must be installed using the system described in the Appendix to these regulations. The method of removal must also be clearly indicated.

**14.6.6** No part of the padding described above may obscure sight of any part of the driver's helmet when he is seated normally and viewed from directly above the car.

**14.6.7** In order to minimise the risk of leg injury during an accident, additional areas of padding must be fitted each side of, and above, the driver's legs.

These areas of padding must :

- Be made from a material described in the Appendix to these regulations.

- Be no less than 25mm thick over their entire area.
- Cover the area situated between points lying 50mm behind the centre of the point at which the second roll structure test is carried out and 100mm behind the face of the rearmost pedal when in the inoperative position, as shown in drawing 4.
- Cover the area above the line A-A shown in drawing 3.

#### **14.7 Wheel retention :**

All cars, whilst under their own power, must be fitted with devices which will retain the wheel fastener in the event of it coming loose.

#### **14.8 Seat fixing and removal :**

**14.8.1** In order that an injured driver may be removed from the car in his seat following an accident, all cars must be fitted with a seat which, if it is secured, must be done so with no more than two bolts. If bolts are used they must :

- Be clearly indicated and easily accessible to rescue crews.
- Be fitted vertically.
- Be removable with the same tool for all teams and which is issued to all rescue crews.

**14.8.2** The seat must be equipped with receptacles which permit the fitting of belts to secure the driver and one which will permit the fitting of a head stabilisation device.

**14.8.3** The seat must be removable without the need to cut or remove any of the seat belts.

**14.8.4** Details of the tool referred to above, the belt receptacles and the head stabilisation device may be found in the Appendix to these regulations.

#### **14.9 Head and neck supports :**

No head and neck support worn by the driver may be less than 25mm from any structural part of the car when he is seated in his normal driving position.

## ARTICLE 15 : CAR CONSTRUCTION

### 15.1 Permitted materials :

15.1.1 The following is the list of permitted materials. These are the only materials permitted to be used in the construction of the Formula One Car provided only that in all cases the material is available on a non-exclusive basis and under normal commercial terms to all competitors.

#### Permitted materials :

- 1) Aluminium alloys.
- 2) Silicon carbide particulate reinforced aluminium alloy matrix composites.
- 3) Steel alloys.
- 4) Cobalt alloys.
- 5) Copper alloys containing  $\leq 2.5\%$  by weight of Beryllium.
- 6) Titanium alloys (but not for use in fasteners with  $<15\text{mm}$  diameter male thread).
- 7) Magnesium alloys.
- 8) Nickel based alloys containing  $50\% < \text{Ni} < 69\%$ .
- 9) Tungsten alloy.
- 10) Thermoplastics : monolithic, particulate filled, short fibre reinforced.
- 11) Thermosets : monolithic, particulate filled, short fibre reinforced.
- 12) Carbon fibres manufactured from polyacrylonitrile (PAN) precursor.(\*)
- 13) Carbon fibres manufactured from polyacrylonitrile (PAN) precursor which have :
  - A tensile modulus  $\leq 550\text{GPa}$ .
  - A density  $\leq 1.92 \text{ g/cm}^3$ .
  - Unidirectional or planar reinforcement within their pre-impregnated form, not including three dimensional weaves or stitched fabrics (but three dimensional preforms and fibre reinforcement using Z-pinning technology are permitted).
  - No carbon nanotubes incorporated within the fibre or its matrix.
  - A permitted matrix, not including a carbon matrix.
- 14) Aramid fibres.
- 15) Poly(p-phenylene benzobisoxazole) fibres (e.g. "Zylon").
- 16) Polyethylene fibres.
- 17) Polypropylene fibres.
- 18) E and S Glass fibres.
- 19) Sandwich panel cores: Aluminium, Nomex, polymer foams, syntactic foams, balsa wood, carbon foam.
- 20) The matrix system utilised in all pre-impregnated materials must be epoxy, cyanate ester, phenolic, bismaleimide, polyurethane, polyester or polyimide based. (\*)
- 21) The matrix system utilised in all pre-impregnated materials must be epoxy, cyanate ester or bismaleimide based.
- 22) Monolithic ceramics.

[Materials marked (\*) are permitted only for parts classified as either front, rear or side impact structures, side intrusion panels or suspension members as regulated by Articles 15.4.3, 15.5.3, 15.4.6, 15.4.7 and 10.3 of the Technical Regulations respectively.]

**Exceptions :**

- 1) All electrical components (e.g. control boxes, wiring looms, sensors).
  - 2) All seals & rubbers (e.g. rubber boots, o-rings, gaskets, any fluid seals, bump rubbers).
  - 3) Fluids (e.g. water, oils).
  - 4) Tyres.
  - 5) Coatings and platings (e.g. DLC, nitriding, chroming).
  - 6) Paint.
  - 7) Adhesives.
  - 8) Thermal insulation (e.g. felts, gold tape, heat shields).
  - 9) All currently regulated materials (e.g. fuel bladder, headrest, extinguishant, padding, skid block).
  - 10) Brake and clutch friction materials.
  - 11) All parts of engines homologated according to Appendix 4 of the Sporting Regulations.
- 15.1.2** No parts of the car may be made from metallic materials which have a specific modulus of elasticity greater than 40GPa / (g/cm<sup>3</sup>). Tests to establish conformity will be carried out in accordance with FIA Test Procedure 03/02, a copy of which may be found in the Appendix to these regulations.

**15.2 Roll structures :**

- 15.2.1** All cars must have two roll structures which are designed to help prevent injury to the driver in the event of the car becoming inverted.

The principal structure must be at least 940mm above the reference plane at a point 30mm behind the cockpit entry template. The second structure must be in front of the steering wheel but no more than 250mm forward of the top of the steering wheel rim in any position.

The two roll structures must be of sufficient height to ensure the driver's helmet and his steering wheel are at least 70mm and 50mm respectively below a line drawn between their highest points at all times.

- 15.2.2** The principal structure must pass a static load test details of which may be found in Article 17.2. Furthermore, each team must supply detailed calculations which clearly show that it is capable of withstanding the same load when the longitudinal component is applied in a forward direction.
- 15.2.3** The highest point of the second structure may not be more than 670mm above the reference plane and must pass a static load test details of which may be found in Article 17.3.
- 15.2.4** The principal roll structure must have a minimum enclosed structural cross section of 10000mm<sup>2</sup>, in vertical projection, across a horizontal plane 50mm below its highest point. The area thus established must not exceed 200mm in length or width and may not be less than 10000mm<sup>2</sup> below this point.
- 15.2.5** The second roll structure must have a minimum enclosed structural cross section of 10000mm<sup>2</sup>, in vertical projection, across a horizontal plane 50mm below its highest point.

### 15.3 Structure behind the driver :

The parts of the survival cell immediately behind the driver which separate the cockpit from the car's fuel tank, and which lie less than 150mm from the car centre line, may be situated no further forward than the line a-b-c-d-e shown in drawing 2.

In order to validate the integrity of this structure the survival cell must pass an impact test against a solid vertical barrier placed at right angles to the car centre line. Details of the test procedure may be found in Article 16.3.

### 15.4 Survival cell specifications :

**15.4.1** Every survival cell must incorporate three FIA supplied transponders for identification purposes. These transponders must be a permanent part of the survival cell, be positioned in accordance with drawing 6 and must be accessible for verification at any time.

**15.4.2** The survival cell must have an opening for the driver, the minimum dimensions of which are given in Article 13.1. Any other openings in the survival cell must be of the minimum size to allow access to mechanical components.

**15.4.3** An impact absorbing structure must be fitted in front of the survival cell. This structure need not be an integral part of the survival cell but must be solidly attached to it.

It must have a minimum external cross section, in horizontal projection, of 9000mm<sup>2</sup> at a point 50mm behind its forward-most point and, furthermore, no part of the cross-section taken at this point may lie more than 500mm above the reference plane.

**15.4.4** Referring to drawing 5 :

The external width of the survival cell between the lines B-B and C-C must be no less than 450mm and must be at least 60mm per side wider than the cockpit opening when measured normal to the inside of the cockpit aperture. These minimum dimensions must be maintained over a height of at least 350mm.

The width of the survival cell may taper forward of the line B-B but, if this is the case, the outer surface must not lie closer to the car centre line than a plane which has a linear taper to a minimum width of 300mm at the line A-A.

The minimum width must be arranged symmetrically about the car centre line, must be maintained over a height of at least 400mm at the line B-B and 275mm at the line A-A. The height at any point between A-A and B-B must not be less than the height defined by a linear taper between these two sections. When assessing the minimum external cross-sections of the survival cell, radii of 50mm at the line B-B, and reducing at a linear rate to 25mm at the line A-A, will be permitted.

Following the application of the permitted radii, the external cross-sections of the survival cell between the lines A-A and B-B must, over their respective minimum widths, have a minimum height of 300mm at the line B-B reducing at a linear rate to a minimum height of 225mm at the line A-A.

The minimum height of the survival cell between the lines A-A and B-B need not be arranged symmetrically about the horizontal centre line of the relevant section but must be maintained over its entire width.

The maximum height of the survival cell between the lines A-A and B-B is 625mm above the reference plane.

The minimum height of the survival cell between the lines B-B and C-C is 550mm.

**15.4.5** When the test referred to in Article 13.1.1 is carried out and the template is in position with its lower edge 525mm above the reference plane, the shape of the survival cell must be such that no part of it is visible when viewed from either side of the car. The parts of the survival cell which are situated each side of the driver's head must be no more than 550mm apart.

In order to ensure that the driver's head is not unduly exposed and for him to maintain good lateral visibility he must, when seated normally and looking straight ahead with his head as far back as possible, have his eye visible when viewed from the side. The centre of gravity of his head must lie below the top of the survival cell at this position. When viewed from the side of the car, the centre of gravity of the driver's head will be deemed to be the intersection of a vertical line passing through the centre of his ear and a horizontal line passing through the centre of his eye.

- 15.4.6** In order to give additional protection to the driver in the event of a side impact a flat test panel of uniform construction, which is designed and constructed in order to represent a section of the survival cell sides, must pass a strength test. Details of the test procedure may be found in Article 18.7.

Referring to drawing 5, with the exception of local re-enforcement and/or inserts, all parts of the survival cell which are as wide or wider than the minimum widths stipulated in Article 15.4.4, including any radii applied, must be manufactured to the same specification as a single panel which satisfies the requirements of Article 18.7. Furthermore, parts to this tested specification must cover an area which :

- Begins no less than 250mm high at the line A-A tapering at a linear rate to a minimum of 450mm high at the line B-B.
- Lies between two horizontal lines 100mm and 550mm above the reference plane between the line B-B and the rear of the survival cell.

- 15.4.7** Once the requirements of Articles 15.4.4, 15.4.6, 15.5.1, 15.5.2, 15.5.4, 15.5.5, 16.1, 16.2, 16.3, 17.1, 17.2, 17.3, 18.1, 18.2, 18.3, 18.4, 18.5, 18.6, 18.7 and 18.9 have been met, panels no less than 6.2mm thick must then be permanently attached to the survival cell sides. These panels must :

- a) In a longitudinal sense, cover the area lying between the line B-B and a vertical plane 50mm to the rear of the rear edge of the cockpit entry template. A 50mm horizontal linear taper may be included at both ends.
- b) In a vertical sense, cover the area lying between two horizontal planes 100mm and 550mm above the reference plane.
- c) Be constructed from 16 plies of Zylon and two plies of carbon, precise lay-up details must be followed and may be found in the Appendix to these regulations.
- d) Be permanently attached to the survival cell with an appropriate adhesive which has been applied over their entire surface.

Cut-outs in these panels totalling 35000mm<sup>2</sup> per side will be permitted for fitting around side impact structures, wiring loom holes and essential fixings.

- 15.4.8** Once the requirements of Articles 15.4.4, 15.4.6, 15.5.1, 15.5.2, 15.5.4, 15.5.5, 16.1, 16.2, 16.3, 17.1, 17.2, 17.3, 18.1, 18.2, 18.3, 18.4, 18.5, 18.6, 18.7 and 18.9 have been met one further panel, which may be made in a maximum of three parts but which is no less than 3.0mm thick, must then be permanently attached to the survival cell. This panel must :

- a) In a longitudinal sense, cover the area lying between a vertical plane 300mm to the rear of the line A-A and a vertical plane 650mm forward of the rear edge of the cockpit entry template. A 25mm horizontal linear taper may be included at both ends.
- b) In a vertical sense, cover every part of the outer skin of the survival cell in the area lying between two horizontal planes 60mm and 550mm above the reference plane. This will not apply at the top of this panel where any radius permitted by Article 15.4.4 falls inside the minimum permitted chassis width nor for the area fitted with the panel defined by Article 15.4.7.



- c) If made in more than one part, have all adjacent parts overlapping by a minimum of 25mm. These overlaps may include linear tapers in the thickness of both parts.
- d) Overlap the panel defined by Article 15.4.7 along all joining edges by a minimum of 25mm. These overlaps may include linear tapers in the thickness of both parts.
- e) Be constructed from seven plies of Zylon and two plies of carbon, precise lay-up details must be followed and may be found in the Appendix to these regulations.
- f) Be permanently attached to the survival cell with an appropriate adhesive which has been applied over its entire surface including all overlapping joints.

Cut-outs in this panel totalling 15000mm<sup>2</sup> per side will be permitted for fitting around wiring loom holes and essential fixings.

### **15.5 Survival cell safety requirements :**

**15.5.1** The survival cell and frontal absorbing structure must pass an impact test against a solid vertical barrier placed at right angles to the car centre line. Details of the test procedure may be found in Article 16.2.

**15.5.2** Between the front and rear roll structures, on each side of the survival cell, impact absorbing structures must be fitted and must be solidly attached to it. The purpose of these structures is to protect the driver in the event of a lateral impact and, in order to ensure this is the case, a lateral strength test in the vicinity of the driver's seating position must be carried out successfully. Details of the test procedure may be found in Article 18.2.2.

The survival cell and one of these impact absorbing structures must pass an impact test, details of the test procedure may be found in Article 16.3. If these structures are not designed and fitted symmetrically about the car centre line a successful impact test must be carried out on them both.

**15.5.3** An impact absorbing structure must be fitted behind the gearbox symmetrically about the car centre line with the centre of area of its rearmost face 300mm (+/-5mm) above the reference plane and no less than 575mm behind the rear wheel centre line.

The rearmost face of the impact structure must be a rectangular section no less than 100mm wide, this minimum width must be maintained over a height of at least 130mm and each corner may incorporate a radius no greater than 10mm.

Furthermore, when viewed from the side, the lowest and highest points of the impact absorbing structure between its rear face and 50mm aft of the rear wheel centre line may not be separated vertically by more than 275 mm.

Between the rear face and the rear wheel centre line no dimension of the area thus defined may diminish nor may any part of the structure or gearbox which is visible from below, other than the permitted radii, be higher than the lower edge of the rear face. Pockets of minimum size within the structure are permitted for the sole purpose of attaching suspension members.

This structure must pass an impact test and must be constructed from materials which will not be substantially affected by the temperatures it is likely to be subjected to during use. Details of the test procedure may be found in Article 16.5.

Only those parts of the structure which genuinely contribute to its performance during the impact test, and which are designed and fitted for that sole purpose, will be considered when assessing compliance with any of the above.

**15.5.4** The survival cell must also be subjected to six separate static load tests :

- 1) On a vertical plane passing through the centre of the fuel tank.
- 2) On a vertical plane passing through the rearmost point at which the outer end of the forward-most front wheel tether would make contact with the survival cell when swung about the inner attachment.

- 3) On a vertical plane 375mm forward of the rear edge of the cockpit entry template.
- 4) From beneath the fuel tank.
- 5) On each side of the cockpit opening.
- 6) From beneath the cockpit floor.

Details of the test procedures may be found in Article 18.2.

**15.5.5** To test the attachments of the frontal, side and rear impact absorbing structures static side load tests must be carried out. Details of these test procedures may be found in Articles 18.6, 18.8 and 18.9.2.

## **ARTICLE 16 : IMPACT TESTING**

### **16.1 Conditions applicable to all impact tests :**

- 16.1.1** All tests must be carried out in accordance with FIA Test Procedure 01/00, in the presence of an FIA technical delegate and by using measuring equipment which has been calibrated to the satisfaction of the FIA technical delegate. A copy of the test procedure may be found in the Appendix to these regulations.
- 16.1.2** Any significant modification introduced into any of the structures tested shall require that part to pass a further test.
- 16.1.3** The reference survival cell must have passed every static load test described in Articles 15.2, 15.5.4 and 15.5.5 before being subjected to any impact test.

### **16.2 Frontal test 1:**

With the exception of the single piece, non-structural fairing described in Article 3.7.9, all parts which could materially affect the outcome of the test must be fitted to the test structure which must be solidly fixed to the trolley through its engine mounting points but not in such a way as to increase its impact resistance.

The fuel tank must be fitted and may contain water.

A dummy weighing at least 75kg must be fitted with safety belts described in Article 14.4 fastened. However, with the safety belts unfastened, the dummy must be able to move forwards freely in the cockpit.

The extinguishers, as described in Article 14.1 must also be fitted.

For the purposes of this test, the total weight of the trolley and test structure shall be 780kg (+1%/-0) and the velocity of impact not less than 15 metres/second.

The resistance of the test structure must be such that during the impact either :

- The peak deceleration over the first 150mm of deformation does not exceed 10g.
- The peak deceleration over the first 60kJ energy absorption does not exceed 20g.
- The average deceleration of the trolley does not exceed 40g.
- The peak deceleration in the chest of the dummy does not exceed 60g for more than a cumulative 3ms, this being the resultant of data from three axes.

Or :

- The peak force over the first 150mm of deformation does not exceed 75kN.
- The peak force over the first 60kJ energy absorption does not exceed 150kN.
- The average deceleration of the trolley does not exceed 40g.
- The peak deceleration in the chest of the dummy does not exceed 60g for more than a cumulative 3ms, this being the resultant of data from three axes.

Furthermore, there must be no damage to the survival cell or to the mountings of the safety belts or fire extinguishers.

This test must be carried out on the survival cell subjected to the higher loads in the tests described in Articles 18.2-5, and on the frontal impact absorbing structure which was subjected to the test described in Article 18.6.

### **16.3 Frontal test 2 :**

A 50mm (+/-1mm) thick aluminium plate should be attached to the front bulkhead of the survival cell through the mounting points of the frontal impact absorbing structure. The plate should :

- Measure 375mm (+/-1mm) wide x 375mm (+/-1mm) high.
- Be fitted symmetrically about the car centre line.
- Be fitted in a vertical sense in order to ensure force distribution is similar to that measured during the first frontal test.
- Have four M10 x 30mm holes in the outer face arranged in a 125mm square pattern about its geometric centre. The test laboratory will then fit a 5mm thick 300mm x 275mm steel plate to these holes using a 5mm washer stack.

All parts which could materially affect the outcome of the test must be fitted to the test structure which must be solidly fixed to the trolley through its engine mounting points but not in such a way as to increase its impact resistance.

The fuel tank must be fitted and must be full of water.

A dummy weighing at least 75kg must be fitted with safety belts described in Article 14.4 fastened. However, with the safety belts unfastened, the dummy must be able to move forwards freely in the cockpit.

For the purposes of this test, the total weight of the trolley and test structure shall be 900kg (+1%/-0) and the velocity of impact not less than 15 metres/second.

The impact wall must be fitted with six 60kN crush tubes which develop a combined 360kN as follows :

- 2 x 60kN from T-zero to T-end, directed into the two lower M10 attachment points.
- 2 x 60kN from T-100mm to T-end, directed into the two upper M10 attachment points.
- 2 x 60kN from T-200mm to T-end, directed into the sled.

The resistance of the test structure must be such that following the impact there is no damage to the survival cell or to the mountings of the safety belts.

This test must be carried out on the survival cell subjected to the higher loads in the tests described in Articles 18.2-5.

Specifications of the crush tubes and test arrangement may be found in the Appendix to these regulations.

#### **16.4 Side test :**

All parts which could materially affect the outcome of the test must be fitted to the test structure which must be solidly fixed to the ground and a solid object, having a mass of 780kg (+1%/-0) and travelling at a velocity of not less than 10 metres/second, will be projected into it.

The object used for this test must :

- Incorporate an impactor assembly, the specification of which may be found in the Appendix to these regulations.
- Be positioned in order that its centre of area strikes the structure 300mm (+/-25mm) above the reference plane and at a point 500mm (+/-3mm) forward of the rear edge of the cockpit opening template.

During the test the striking object may not pivot in any axis and the survival cell may be supported in any way provided this does not increase the impact resistance of the parts being tested. The impact axis must be perpendicular to the car centre line and parallel to the ground.

The resistance of the test structure must be such that during the impact :

- The average deceleration of the object, measured in the direction of impact, does not exceed 20g.
- The force applied to any one of the four impactor segments does not exceed 80kN for more than a cumulative 3ms.
- The energy absorbed by each of the four impactor segments must be between 15% and 35% of the total energy absorption.

Furthermore, all structural damage must be contained within the impact absorbing structure.

This test must be carried out on the survival cell subjected to the higher loads in the tests described in Articles 18.2-5 and on the side impact absorbing structure(s) which were subjected to the test described in Article 18.9.

#### **16.5 Rear test :**

All parts which will be fitted behind the rear face of the engine and which could materially affect the outcome of the test must be fitted to the test structure. If suspension members are to be mounted on the structure they must be fitted for the test. The structure and the gearbox must be solidly fixed to the ground and a solid object, having a mass of 780kg (+1%/-0) and travelling at a velocity of not less than 11 metres/second, will be projected into it.

The object used for this test must be flat, measure 450mm (+/-3mm) wide by 550mm (+/-3mm) high and may have a 10mm radius on all edges. Its lower edge must be at the same level as the car reference plane (+/-3mm) and must be so arranged to strike the structure vertically and at 90° to the car centre line.

During the test, the striking object may not pivot in any axis and the crash structure may be supported in any way provided this does not increase the impact resistance of the parts being tested.

The resistance of the test structure must be such that during the impact :

- The peak deceleration over the first 225mm of deformation does not exceed 20g.
- The maximum deceleration does not exceed 20g for more than a cumulative 15ms, this being measured only in the direction of impact.

Furthermore, all structural damage must be contained within the area behind the rear wheel centre line.

This test must be carried out on the rear impact absorbing structure which was subjected to the test described in Article 18.8.

#### **16.6 Steering column test :**

The parts referred to in Article 10.4.4 must be fitted to a representative test structure; any other parts which could materially affect the outcome of the test must also be fitted. The test structure must be solidly fixed to the ground and a solid object, having a mass of 8kg (+1%/-0) and travelling at a velocity of not less than 7metres/second, will be projected into it.

The object used for this test must be hemispherical with a diameter of 165mm (+/-1mm).

For the test, the centre of the hemisphere must strike the structure at the centre of the steering wheel along the same axis as the main part of the steering column.

During the test the striking object may not pivot in any axis and the test structure may be supported in any way provided this does not increase the impact resistance of the parts being tested.

The resistance of the test structure must be such that during the impact the peak deceleration of the object does not exceed 80g for more than a cumulative 3ms, this being measured only in the direction of impact.

After the test, all substantial deformation must be within the steering column and the steering wheel quick release mechanism must still function normally.

## **ARTICLE 17 : ROLL STRUCTURE TESTING**

### **17.1 Conditions applicable to both roll structure tests :**

- 17.1.1 Rubber 3mm thick may be used between the load pads and the roll structure.
- 17.1.2 Both peak loads must be applied in less than three minutes and be maintained for 10 seconds.
- 17.1.3 Under the load, deformation must be less than 25mm in the case of the principal roll structure and 50mm in the case of the second roll structure, measured along the loading axis and any structural failure limited to 100mm below the top of the rollover structure when measured vertically.
- 17.1.4 Any significant modification introduced into any of the structures tested shall require that part to pass a further test.

### **17.2 Principal roll structure test :**

A load equivalent to 50kN laterally, 60kN longitudinally in a rearward direction and 90kN vertically, must be applied to the top of the structure through a rigid flat pad which is 200mm in diameter and perpendicular to the loading axis.

During the test, the roll structure must be attached to the survival cell which is supported on its underside on a flat plate, fixed to it through its engine mounting points and wedged laterally by any of the static load test pads described in Article 18.2.

### **17.3 Second roll structure test :**

A vertical load of 75kN must be applied to the top of the structure through a rigid flat pad which is 100mm in diameter and perpendicular to the loading axis.

During the test, the rollover structure must be attached to the survival cell which is fixed to a flat horizontal plate.

## **ARTICLE 18 : STATIC LOAD TESTING**

### **18.1 Conditions applicable to all static load tests :**

**18.1.1** The tests described in Articles 18.2, 18.3, 18.4, 18.5, 18.6 and 18.9.2 must be carried out on the survival cell which will be subjected to the impact tests described in Article 16.

**18.1.2** Every subsequent survival cell produced must also be subjected to the tests described in Articles 18.2, 18.3, 18.4 and 18.5.

However, the tests described in Articles 18.2.1, 18.3, 18.4 and 18.5 may be carried out on subsequent survival cells with peak loads reduced by 20%. During these tests (on deflections greater than 3.0mm), the deflection across the inner surfaces must not exceed 120% of the deflection obtained at 80% of the peak load during the first test.

**18.1.3** Deflections and deformations will be measured at the centre of area of circular load pads and at the top of rectangular pads.

**18.1.4** All peak loads must be applied in less than three minutes, through a ball jointed junction at the centre of area of the pad, and maintained for 30 seconds.

**18.1.5** Following the tests described in 18.2, 18.3, 18.4 and 18.5, permanent deformation must be less than 1.0mm (0.5mm in 18.3 and 18.4) after the load has been released for 1 minute.

**18.1.6** All tests must be carried out by using measuring equipment which has been calibrated to the satisfaction of the FIA technical delegate.

**18.1.7** A radius of 3mm is permissible on the edges of all load pads and rubber 3mm thick may be placed between them and the test structure.

**18.1.8** For the tests described in 18.2, 18.3, 18.4 and 18.5, the survival cells must always be produced in an identical condition in order that their weights may be compared. If the weight differs by more than 5% from the one subjected to the impact tests described in Articles 16.2 and 16.3 further frontal and side impact tests and roll structure tests must be carried out.

**18.1.9** Any significant modification introduced into any of the structures tested shall require that part to pass a further test.

### **18.2 Survival cell side tests :**

**18.2.1** For test 1, referred to in Article 15.5.4, pads 100mm long and 300mm high, which conform to the shape of the survival cell, must be placed against the outermost sides of the survival cell with the lower edge of the pad at the lowest part of the survival cell at that section.

A constant transverse horizontal load of 25.0kN will be applied and, under the load, there must be no structural failure of the inner or outer surfaces of the survival cell.

**18.2.2** For test 2), referred to in Article 15.5.4, pads 200mm in diameter which conform to the shape of the survival cell, must be placed against the outermost sides of the survival cell.

The centre of the pads must pass through the plane mentioned above and the mid point of the height of the structure at that section.

A constant transverse horizontal load of 30.0kN will be applied to the pads and, under the load, there must be no structural failure of the inner or outer surfaces of the survival cell and the total deflection must not exceed 15mm.

**18.2.3** For test 3), referred to in Article 15.5.4, pads 200mm in diameter which conform to the shape of the survival cell, must be placed against the outermost sides of the survival cell.

The centre of the pads must be located 350mm above the reference plane and on the vertical plane mentioned in Article 15.5.4.



A constant transverse horizontal load of 30.0kN will be applied to the pads and, under the load, there must be no structural failure of the inner or outer surfaces of the survival cell and the total deflection must not exceed 15mm.

### **18.3 Fuel tank floor test :**

A pad of 200mm diameter must be placed in the centre of area of the fuel tank floor and a vertical upwards load of 12.5kN applied.

Under the load, there must be no structural failure of the inner or outer surfaces of the survival cell.

### **18.4 Cockpit floor test :**

A pad of 200mm diameter must be placed beneath the survival cell, on the car centre line and with its centre 600mm forward of the rear edge of the cockpit entry template, and a vertical upwards load of 15kN applied.

Under the load, there must be no structural failure of the inner or outer surfaces of the survival cell.

### **18.5 Cockpit rim tests :**

Two pads, each of which is 50mm in diameter, must be placed on both sides of the cockpit rim with their upper edges at the same height as the top of the cockpit side with their centres at a point 250mm forward of the rear edge of the cockpit opening template longitudinally.

A constant transverse horizontal load of 15.0kN will then be applied at 90° to the car centre line and, under the load, there must be no structural failure of the inner or outer surfaces of the survival cell and the total deflection must not exceed 20mm.

This test must be repeated at positions 50mm and 150mm forward of the rear edge of the cockpit opening template longitudinally.

### **18.6 Nose push off test :**

During the test the survival cell must be resting on a flat plate and secured to it solidly but not in a way that could increase the strength of the attachments being tested.

A constant transversal horizontal load of 40.0kN must then be applied to one side of the impact absorbing structure, using a pad identical to the ones used in the lateral tests in Article 18.2.1, at a point 550mm from the front wheel axis.

The centre of area of the pad must pass through the plane mentioned above and the mid point of the height of the structure at the relevant section. After 30 seconds of application, there must be no failure of the structure or of any attachment between the structure and the survival cell.

### **18.7 Side intrusion test :**

**18.7.1** The test must be carried out in accordance with FIA Test Procedure 02/05, in the presence of an FIA technical delegate and by using measuring equipment which has been calibrated to the satisfaction of the FIA technical delegate. A copy of the test procedure may be found in the Appendix to these regulations.

**18.7.2** The test panel must be 500mm x 500mm and will be tested by forcing a rigid truncated cone through the centre of the panel at a rate of 2mm (+/-1mm) per second until the displacement exceeds 150mm.

During the first 100mm of displacement the load must exceed 250kN and the energy absorption must exceed 6000J. There must be no systematic damage to the border or damage to the fixture before these requirements have been met.

### **18.8 Rear impact structure push off test :**

During the test the gearbox and the structure must be solidly fixed to the ground but not in a way that could increase the strength of the attachments being tested.

A constant transversal horizontal load of 40kN must then be applied to one side of the impact absorbing structure, using a pad identical to the ones used in the lateral tests in Article 18.2.1, at a point 400mm behind the rear wheel axis.

The centre of area of the pad must pass through the plane mentioned above and the mid point of the height of the structure at the relevant section. After 30 seconds of application, there must be no failure of the structure or of any attachment between the structure and the gearbox.

### **18.9 Side impact structure push off tests :**

**18.9.1** Each team must supply detailed calculations which clearly show that the structure(s) are capable of withstanding :

- Horizontal loads of 20kN applied separately in a forward and a rearward direction by a ball-jointed pad, which may conform to the shape of the structure(s), measuring 550mm high x 100mm wide and whose centre of area lies 600mm from the car centre line and 300mm above the reference plane.
- A vertical load of 10kN applied in an upward or downward direction by a ball-jointed pad, which may conform to the shape of the structure(s), measuring 400mm long x 100mm wide whose centre of area lies 600mm from the car centre line and 500mm forward of the rear edge of the cockpit entry template.

In all cases the calculations should show that there will be no structural failure of the parts. It should be assumed that ball-jointed pads are used, the joint lying at the centre of area of the pad.

If multiple impact structures are fitted to the car only those in contact with the pads need have the load applied to them.

**18.9.2** During the push off tests the survival cell must be resting on a flat plate and secured to it solidly but not in a way that could increase the strength of the attachments being tested.

During the first test a constant rearward horizontal load of 20.0kN must then be applied to the impact absorbing structure(s) using a ball-jointed pad 550mm high and 100mm wide, which may conform to the shape of the structure(s), whose centre of area lies 600mm from the car centre line.

The centre of area of the pad must lie 300mm above the reference plane and there must be no failure of any structure or of any attachment between the structure(s) and the survival cell.

If multiple impact structures are fitted to the car only those in contact with the pads will be tested.

During the second test a constant upward vertical load of 10.0kN must then be applied to the impact absorbing structure(s) using a ball-jointed pad 400mm long and 100mm wide, which may conform to the shape of the structure(s), whose centre of area lies 600mm from the car centre line.

The centre of area of the pad must lie 500mm forward of the rear edge of the cockpit entry template and there must be no failure of any structure or of any attachment between the structure(s) and the survival cell.

If multiple impact structures are fitted to the car only those in contact with the pads will be tested.

## ARTICLE 19 : FUEL

### 19.1 Purpose of Article 19 :

- 19.1.1 The purpose of this Article is to ensure that the fuel used in Formula One is petrol as this term is generally understood.
- 19.1.2 The detailed requirements of this Article are intended to ensure the use of fuels that are composed of compounds normally found in commercial fuels and to prohibit the use of specific power-boosting chemical compounds. Acceptable compounds and compound classes are defined in 19.2 and 19.4.3. In addition, to cover the presence of low level impurities, the sum of components lying outside the 19.2 and 19.4.3 definitions are limited to 1% max m/m of the total fuel.
- 19.1.3 Any petrol, which appears to have been formulated in order to subvert the purpose of this regulation, will be deemed to be outside it.

### 19.2 Definitions :

- Paraffins - Straight chain and branched alkanes.
- Olefins - Straight chain and branched mono-olefins and di-olefins.  
- Monocyclic mono-olefins (with five or more carbon atoms in the ring) with or-without paraffinic side chains.
- Di-olefins - Straight chain or branched or monocyclic hydrocarbons (with five or more carbon atoms in any ring) with or without paraffinic side chains, containing two double bonds per molecule.
- Naphthenes - Monocyclic alkanes (with five or more carbon atoms in the ring) with or without paraffinic side chains.
- Aromatics - Monocyclic and bicyclic aromatic rings with or without paraffinic or olefinic side chains. Only one double bond may be present outside the aromatic ring.
- Oxygenates - Organic compounds containing oxygen.
- Biocomponents - Paraffins, olefins, di-olefins, naphthenes, aromatics and oxygenates, as defined above, derived in whole or part from biological origins. For the purposes of quantification, the biocomponent contribution of a given molecule is defined as the carbon, hydrogen and oxygen atoms from biological origin as a percent of the total molecule, on a mass/mass basis. The biocomponent contribution of a co-produced stream is determined as the bio feedstock percentage on a mass/mass basis.

### 19.3 Properties :

The only fuel permitted is petrol having the following characteristics :

Property	Units	Min	Max	Test Method
(RON+MON)/2		87.0		ASTM D 2699/D 2700
Oxygen	wt%		3.7	Elemental Analysis
Nitrogen	mg/kg		500	ASTM D 4629
Benzene	wt%		1.0	GC-MS
RVP	kPa	45	60 <sup>(1)</sup>	EN13016-1
Lead	g/l		0.005	ASTM D 3237
Oxidation Stability	minutes	360		ASTM D 525
Sulphur	mg/kg		10	EN ISO 20846

	Electrical conductivity	pS/m	200	ASTM D 2624
	Final Boiling Point	°C	210	ISO 3405
	Distillation Residue	%v/v	2.0	ISO 3405
(1)	The maximum RVP may rise to 68kPa if a minimum of 2% bio-methanol and/or bio-ethanol are included in the fuel.			

The fuel will be accepted or rejected according to ASTM D 3244 with a confidence limit of 95%.

#### 19.4 Composition of the fuel :

19.4.1 The composition of the petrol must comply with the specifications detailed below :

Component	Units	Min	Max	Test Method
Aromatics	wt%		*40	GCMS
Olefins	wt%		*17	GCMS
Total di-olefins	wt%		1.0	GCMS
Total styrene and alkyl derivatives	wt%		1.0	GCMS

\* Values corrected for fuel oxygen content.

In addition, the fuel must contain no substance which is capable of exothermic reaction in the absence of external oxygen.

19.4.2 The total of individual hydrocarbon components present at concentrations of less than 5% m/m of the total fuel must be at least 30% m/m of the hydrocarbon component of the fuel.

19.4.3 The only oxygenates permitted are paraffinic mono-alcohols and paraffinic mono-ethers with a final boiling point below 210°C.

19.4.4 A minimum of 5.75% (m/m) of the fuel must comprise bio-components.

19.4.5 Initially the bio-components are restricted to oxygenates. However, hydrocarbons (as defined in 19.2) and oxygenates (lying outside the 19.4.3 definition) or mixtures thereof, which have been produced from biomass, may be included in the Formula One fuel as part of the 5.75% biocomponents quota, provided that a suitable analytical procedure is available for their quantification and to verify their biological origin. Their use in F1 fuel will be dependent on evidence indicating that the supplier is genuinely developing these compounds for use in commercial fuels.

19.4.6 Manganese based additives are not permitted.

#### 19.5 Air :

Only ambient air may be mixed with the fuel as an oxidant.

#### 19.6 Safety :

19.6.1 All competitors must be in possession of a Material Safety Data Sheet for each type of petrol used. This sheet must be made out in accordance with EC Directive 93/112/EEC and all information contained therein strictly adhered to.

#### 19.7 Fuel approval :

19.7.1 Before any fuel may be used in an Event, two separate five litre samples, in suitable containers, must be submitted to the FIA for analysis and approval.

19.7.2 No fuel may be used in an Event without prior written approval of the FIA.

#### 19.8 Sampling and testing at an Event:

19.8.1 All samples will be taken in accordance with the FIA Formula One fuel sampling procedure, a copy of which may be found in the Appendix to these regulations.

**19.8.2** Fuel samples taken during an Event will be checked for conformity by using a gas chromatographic technique, which will compare the sample taken with an approved fuel. Samples which differ from the approved fuel in a manner consistent with evaporative loss, will be considered to conform. However, the FIA retains the right to subject the fuel sample to further testing at an FIA approved laboratory.

**19.8.3** GC peak areas of the sample will be compared with those obtained from the reference fuel. Increases in any given peak area (relative to its adjacent peak areas) which are greater than 12%, or an absolute amount greater than 0.1% for compounds present at concentrations below 0.8%, will be deemed not to comply.

If a peak is detected in a fuel sample that was absent in the corresponding reference fuel, and its peak area represents more than 0.10% of the summed peak areas of the fuel, the fuel will be deemed not to comply.

If the deviations observed (above) by GC indicate that they are due to mixing with another Formula One fuel, which has been approved by the FIA for use by the team, the fuel sample will be deemed to comply, provided that the adulterant fuel is present at no more than 10% in the sample.

## **ARTICLE 20 : TELEVISION CAMERAS AND TIMING TRANSPONDERS**

### **20.1 Presence of cameras and camera housings :**

All cars must be fitted with at least five cameras or camera housings at all times throughout the Event.

### **20.2 Location of camera housings :**

Camera housings, when used, must be fitted in the same location as cameras. Details concerning the size and weight of all camera housings may be found in the Appendix to these regulations.

### **20.3 Location and fitting of camera equipment :**

**20.3.1** All cars must be equipped with five positions in which cameras or camera housings can be fitted. Referring to drawing 6, all cars must carry (i) a camera in position 4 and (ii) a camera or camera housing in positions 2 (both sides), 3 and either 1 or 5.

Any decision as to whether a camera or camera housing is fitted in those positions will be by agreement between the relevant Competitor and the Commercial Rights Holder.

**20.3.2** Any part provided by the Competitor for the purpose of aligning a camera or camera housing in positions 2 or 3 correctly will be considered part of the camera or housing provided it is being fitted for that sole purpose.

**20.3.3** Any camera or camera housing fitted in positions 2, 3 or 4 shown in drawing 6 must be mounted in order that its major axis does not subtend an angle greater than 1° to the reference plane.

**20.3.4** Any camera or camera housing fitted in the left hand position 2 shown in drawing 6 must be mounted in order that its major axis where passing through the centre of the camera lens (or corresponding position for a camera housing) does not intersect any part of the car lying forward of the camera or camera housing.

**20.3.5** The camera fitted in position 4 shown in drawing 6 must be mounted in order that its forward-most point is no more than 80mm rearward of the rear face of the cockpit entry template.

### **20.4 Transponders :**

All cars must be fitted with two timing transponders supplied by the officially appointed timekeepers. These transponders must be fitted in strict accordance with the instructions detailed in the Appendix to these regulations.

### **20.5 Installation :**

Competitors must be notified of any changes to the camera or transponder installation instructions before 30 June of the previous season.

**ARTICLE 21 : FINAL TEXT**

The final text for these regulations shall be the English version should any dispute arise over their interpretation.

**Drawing 1**



**Skid Block Dimensions**

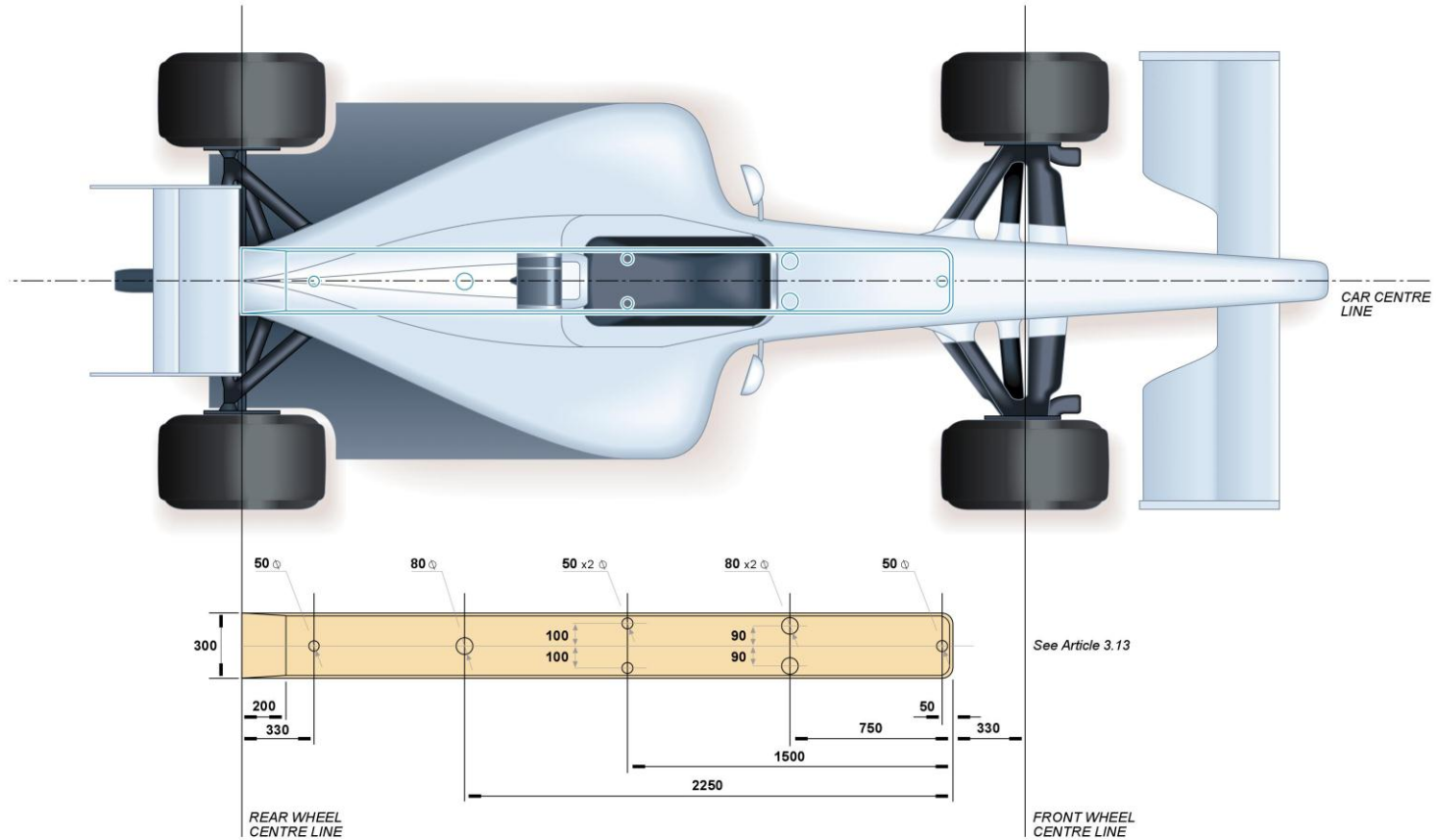





# Drawing 3



## Cockpit Cross Section Template

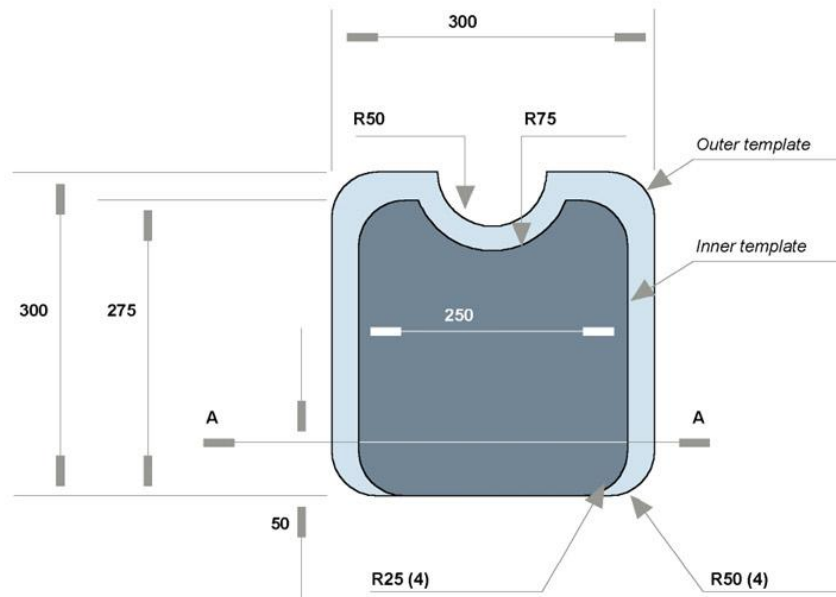

See Article 13.3.1 & Article 14.6.7

# Drawing 4



## Cockpit Padding

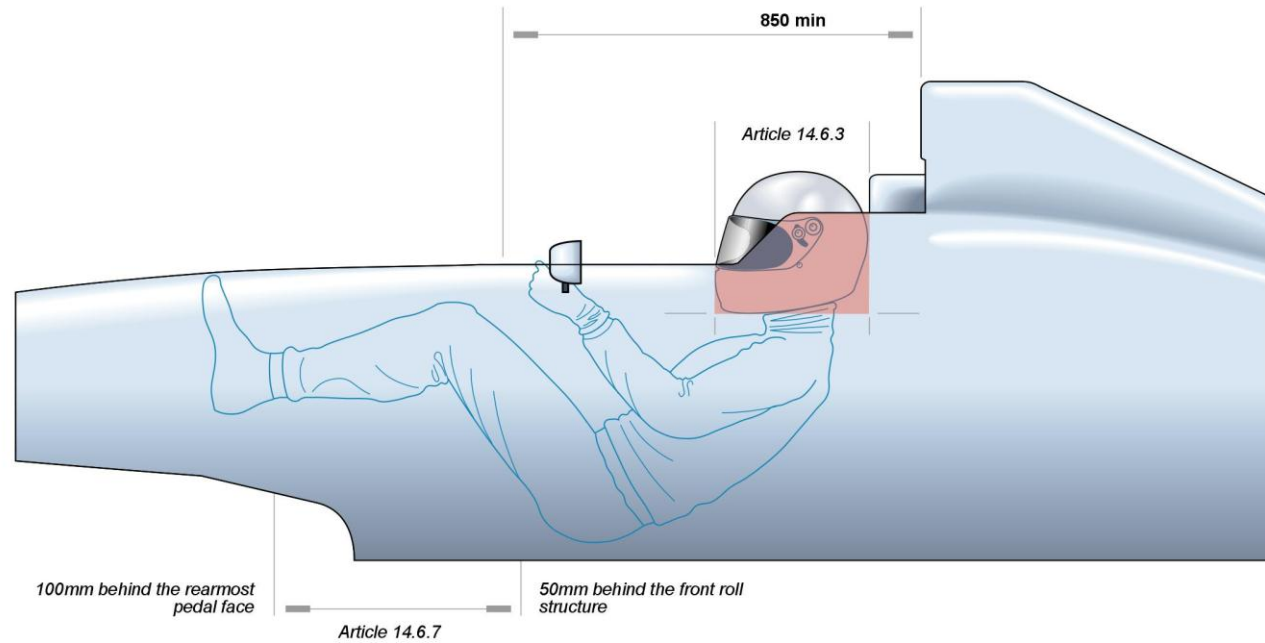

# Drawing 5



## Survival Cell Dimensions

See Article 13.1.1, Article 15.4.4, Article 15.4.6

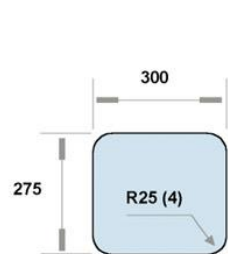
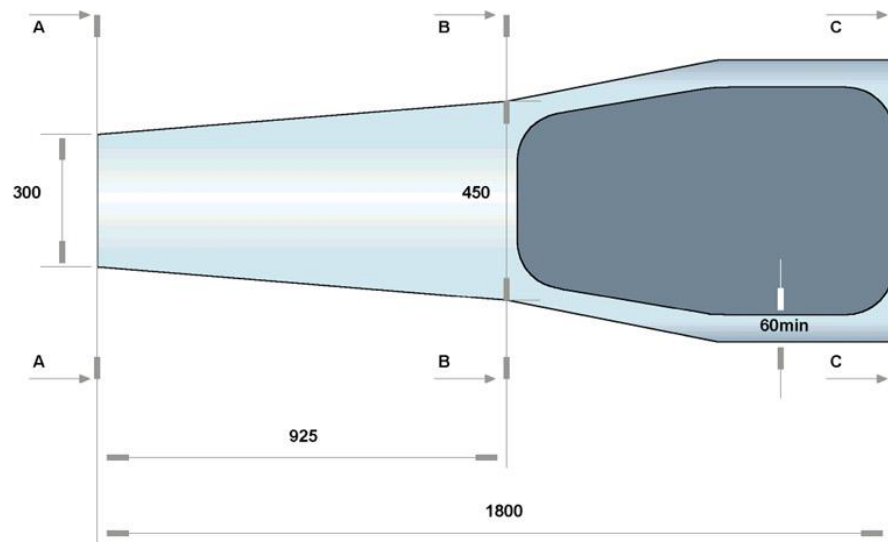

Minimum external dimensions at the section A-A

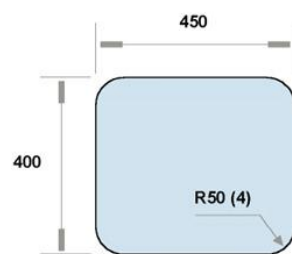

Minimum external dimensions at the section B-B

**Drawing 6**



**Cameras and Transponders**

■ Camera locations

● Transponder locations

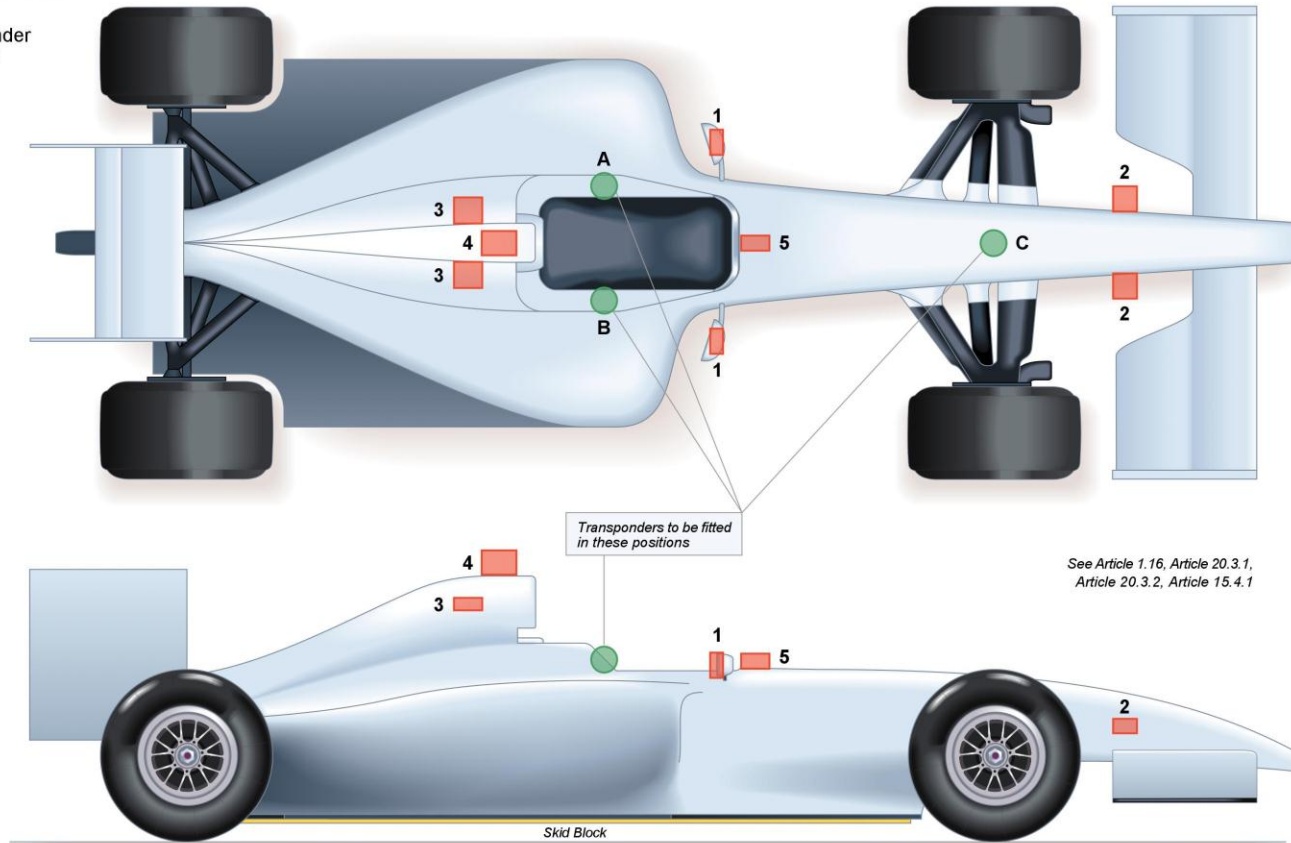

# Drawing 7



## Front Wing Section - Side & Front View

### Front Wing Co-ordinates

TE upper		Highest		LE		Lowest	
x	y	x	y	x	y	x	y
-760.506	88.605	-933.867	120.391	-999.999	103.784	-875.371	75.000
-760.957	88.749	-936.245	120.389	-999.956	103.015	-872.484	75.007
-761.778	89.003	-938.592	120.369	-999.835	102.418	-869.587	75.033
-762.825	89.332	-940.904	120.338	-999.664	101.808	-866.680	75.078
-764.061	89.716	-943.189	120.289	-999.424	101.222	-863.769	75.143
-765.447	90.149	-946.435	120.230	-999.128	100.584	-860.848	75.224
-766.969	90.621	-947.649	120.156	-998.766	99.969	-857.926	75.324
-768.606	91.124	-949.824	120.072	-998.348	99.354	-855.003	75.441
-770.353	91.663	-951.965	119.969	-997.869	98.743	-852.074	75.577
-772.194	92.229	-954.070	119.855	-997.330	98.140	-849.144	75.733
-774.125	92.821	-956.136	119.727	-996.735	97.537	-846.217	75.905
-776.136	93.431	-958.162	119.588	-996.079	96.938	-843.293	76.093
-778.221	94.062	-960.150	119.430	-995.366	96.347	-840.375	76.298
-780.373	94.710	-962.099	119.262	-994.598	95.756	-837.461	76.520
-782.592	95.374	-964.004	119.082	-993.776	95.173	-834.553	76.757
-784.866	96.054	-965.870	118.884	-992.894	94.598	-831.657	77.008
-787.200	96.743	-967.693	118.675	-991.960	94.024	-828.771	77.275
-789.581	97.439	-969.477	118.455	-990.969	93.457	-825.897	77.551
-792.009	98.146	-971.214	118.219	-989.926	92.895	-823.037	77.845
-794.486	98.860	-972.907	117.969	-988.826	92.341	-820.193	78.147
-797.002	99.577	-974.554	117.703	-987.677	91.791	-817.369	78.459
-799.554	100.297	-976.157	117.426	-986.476	91.246	-814.567	78.784
-802.146	101.020	-977.713	117.138	-985.223	90.709	-811.785	79.115
-804.770	101.745	-979.222	116.835	-983.917	90.177	-809.031	79.452
-807.422	102.467	-980.684	116.516	-982.562	89.653	-806.304	79.798
-810.102	103.184	-982.098	116.186	-981.159	89.134	-803.605	80.151
-812.811	103.899	-983.486	115.840	-979.707	88.624	-800.938	80.506
-815.540	104.611	-984.782	115.483	-978.206	88.122	-798.310	80.863
-818.294	105.313	-986.047	115.110	-976.657	87.624	-795.719	81.223
-821.068	106.008	-987.261	114.726	-975.064	87.132	-793.167	81.586
-823.859	106.696	-988.427	114.331	-973.421	86.648	-790.664	81.948
-826.666	107.370	-989.538	113.919	-971.734	86.174	-788.209	82.306
-829.487	108.036	-990.598	113.496	-969.999	85.707	-785.802	82.663
-832.320	108.687	-991.604	113.057	-968.223	85.246	-783.456	83.020
-835.167	109.327	-992.557	112.610	-966.402	84.790	-781.166	83.369
-838.022	109.952	-993.451	112.148	-964.540	84.347	-778.945	83.711
-840.882	110.561	-994.295	111.669	-962.634	83.909	-776.792	84.046
-843.752	111.155	-995.083	111.183	-960.688	83.476	-774.716	84.370
-846.627	111.733	-995.816	110.681	-958.700	83.057	-772.721	84.687
-849.507	112.295	-996.489	110.167	-956.672	82.642	-770.819	84.992
-852.388	112.837	-997.107	109.645	-954.603	82.237	-769.015	85.282
-855.266	113.359	-997.666	109.106	-952.498	81.837	-767.324	85.553
-858.146	113.865	-998.165	108.556	-950.356	81.451	-765.750	85.808
-861.027	114.352	-998.610	107.997	-948.173	81.070	-764.318	86.045
-863.901	114.821	-998.992	107.407	-945.958	80.698	-763.041	86.252
-866.773	115.271	-999.311	106.860	-943.702	80.332	-761.957	86.433
-869.638	115.700	-999.579	106.281	-941.417	79.980	-761.110	86.570
-872.497	116.108	-999.768	105.705	-939.095	79.633		
-875.348	116.496	-999.917	104.949	-936.741	79.300		
-878.189	116.867	-999.990	104.369	-934.354	78.972		
-881.020	117.217			-931.934	78.655		
-883.840	117.547			-929.485	78.347		
-886.649	117.859			-927.004	78.049		
-889.440	118.147			-924.494	77.766		
-892.219	118.421			-921.959	77.492		
-894.985	118.671			-919.395	77.225		
-897.731	118.907			-916.802	76.975		
-900.459	119.118			-914.185	76.732		
-903.168	119.315			-911.546	76.507		
-905.858	119.491			-908.879	76.293		
-908.529	119.650			-906.190	76.093		
-911.174	119.795			-903.480	75.911		
-913.799	119.918			-900.749	75.740		
-916.402	120.032			-897.997	75.592		
-918.978	120.124			-895.224	75.454		
-921.526	120.206			-892.433	75.339		
-924.051	120.274			-889.629	75.236		
-926.550	120.325			-886.804	75.154		
-929.018	120.361			-883.966	75.088		
-931.458	120.383			-881.114	75.041		
				-878.249	75.013		

